

Introduction

CATIA 3DEXPERIENCE Electrical 3D Design

Wrqp"eq o rnvkqp"qh"vjku"eqwtug"vjg"uvwfgpv"ujqwnf"jcxg"c"hwmm"wpfgtuvcpfkpi"qh"vjg
hqnnqykpi"vqrkeu<

- / Fghkpg"gngevtkecn"igq o gvt{"cpf"dcpcejgu
- /" Fghkpg"eq o rnvvg"jctpguugu"ykvj"uwrrqtvu
- / Fgxnqr"jctpguugu"ykvjkpvjg"eqpvz"qh"c"rtqfwev
- / Fgxnqr"cpf"vknk|g"c"jctpguu"kp" o wvkrng"rtqfwevu
- / Etcvg"hqto dqctfu"hqthm"cvvgpkpi"cpf"qrvkok|kpi"c"jctpguu"hqto cpwhcevwtkpi

Electrical 3D Design

Fghkpkp i "cp" gngevtkeci" jctpguu" tgs wktgu" v y q" uvgru0"" [qw" o wuv" hktuv" fghkpg" v j g" tgs wktgf
eqppgevtu" cpf" eqppgevkqp" r qkpvu0"" Qpeg" { qw" j cxg" v j gug" eqppgevkqpu." { qw" ctg" tgc f { "vq" dg i kp
fghkpkp i "v j g" i gq o gvtke" dwpfng" v j cv" nkpmu" v j g" xctkwu" eqppgevkqp" r qkpvu0"" V j gug" i gq o gvtke

Electrical Harness Design

Kp"vjku"ugevkqp." {qw"yknn"nqqm"cv"fgxgnqrkpi" c"uk o rng"ukping"dtcpej" jctpguu0""Mggr"kp" okpf.
 {qw"yknn"dg"wukpi" dqvj"vjg"Gngevtkecn"5F" Fgukip"cpf"Gngevtkecn"5F"Rctv" Fgukip
 yqtm dgpejgu0""Vjgug"vyq"yqtm dgpejgu"yqtm"vqigvjgt"vq" fghkpg"vjg"jctpguu"cpf"vjg" dwpfngu0

Defining Electrical Branch Geometry

Kp"vjku" hktuv"gzgtekug." {qw"ctg"iqkpi"vq"nqqm"cv"etgcvkpi" c"dcuke"gngevtkecn"dtcpej" dgvyggp"vyq
 eqppgevtu0""Cu" {qw"eqpvkpwg"vjtwij"vjku"dqqm." {qw"yknn" hkp f"vjg"jctpguu"cpf"dtcpejgu
 dgeqokpi" oqtg"cpf" oqtg"eqo rngz"cu"vjg"qrvkqpu"ctg"eqxgtgf"kp" oqtg" fgvckn0

&UHDWH D QHZ SURGXFW QDP MjG"pgy"(r&fwev"yknn"dg"cu" H V V
 {qwt" hktuv"jctpguu0"

,I QRW DOUHDG\ VKKH(OHFWZULWFDKO W'R'FWJL"y"cu"zR"U"NEH
 vq"dwknf"vjg"gngevtkecn"jctpguu0"

6HOH Electrical Geometry LFRQ W ELEC060 - Harness IURP WKH
 VSHFLILFD "Rjg"Electrical Geometry"ykpfy"crngctu0

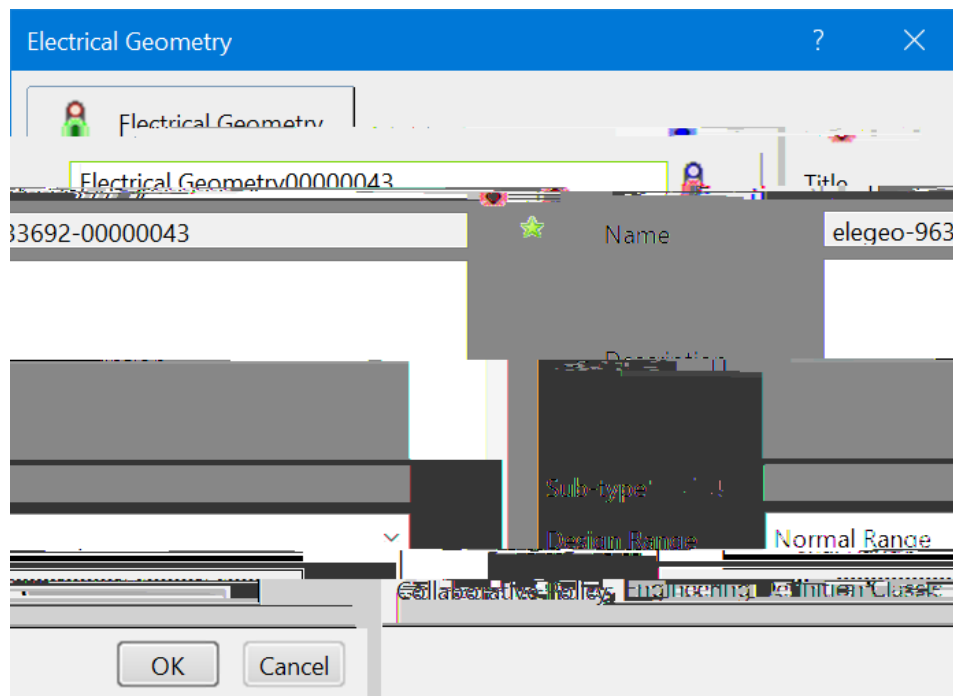

&K D Q J Hltw MVR (/(& (O H F W U L F O G V K B R J W U r g c t " c u
 u j q y p 0

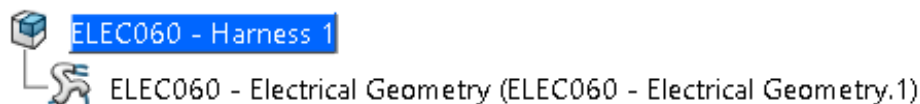

5 LJKW FLEEC010 Electrical Geometry LQ WKH VSHFLILFD WskRQ WUHH D
Existing 3D Part Vjku" yknn" fku rnc{"vjg" Search Selection" ykpfqy0"

6 HDUFK IRU D ELEC-V4 Pin Mount Connector GRFXPHQW IURP WKH
Electrical Harness I G L U H F W k u R y l n d g " c " u k o r n g " h q w t " r k p " o q w p k p i " e q p p g e v q t 0

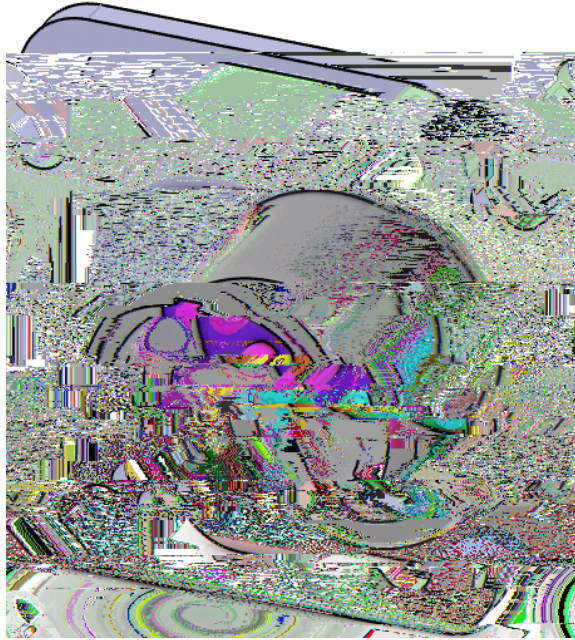

Tg o g o d g t . " { q w " e c p " c n u q " k p u g t v " e q o r q p p v u " h t q o " v j g " e c v c n q i 0

6 HOH Catalog Browser LFRQ IURP WKH ERW W R P j g W R O E D U
ugevkqp0" Vjku" yknn" fku rnc{"vjg" Catalog Browser" ykpfqy0"

6 HDUFK IRU D ELEC- Electrical Catalog WKHQ H [S o n e C o r s W K H
FKDSWHU D Q S g m h o r t h e m e c w r k h i d p l v o j q w n f " e r r g e t " c u " u j q y p 0

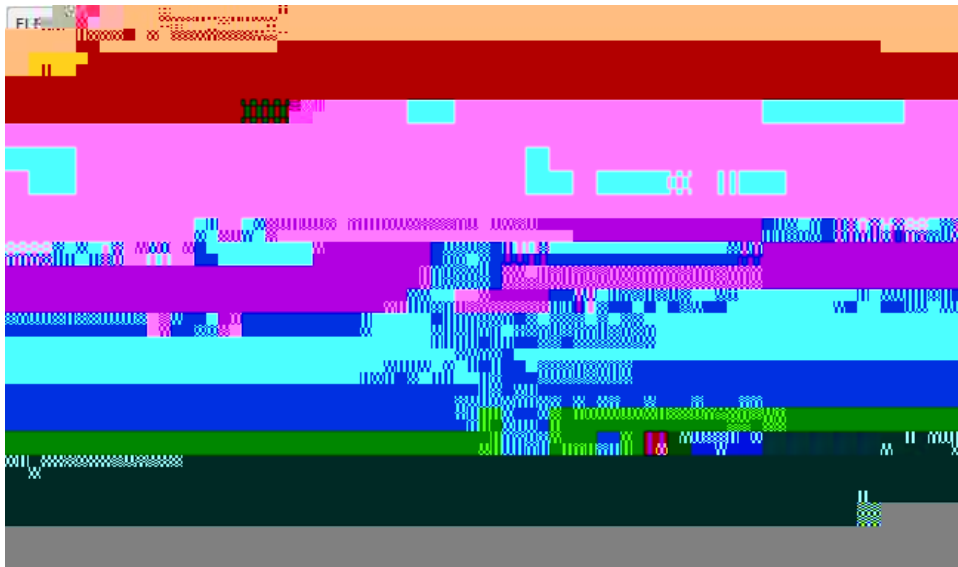

6 HOH ELEC-4 Pin Connector IURP WKH FDWDORJ EURZVHU ZKHQ GRQH
ELEC - 4 Pin Connector IURP WKH FDWDORJ EURZVHU ZKHQ GRQH
eqppgevqt "kpvc"vjg"cuug o dn {"cu" y gmn0

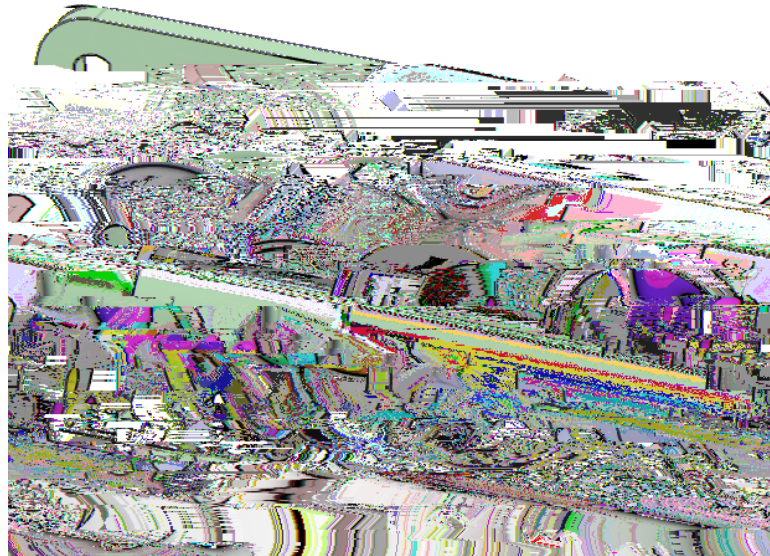

&ORVH WKH FDWDORJ EURZVHU ZKHQ GRQH

'RXEOH VHO ELEC-4 Pin Connector IURP WKH FDWDORJ EURZVHU ZKHQ GRQH
ELEC-4 Pin Connector IURP WKH FDWDORJ EURZVHU ZKHQ GRQH
cnnqy {"qw"vq" ocpkrwncvg"vjg"eq o rppgvu" ykvj kp"kv0"

8VLQJ WKH FRPSDVV DRWL R Q WVRUR DVQ IPSXQ \$ R Q D W F W R K U W F
DSSUR [LPDWH O R F D W L R Q W K R Z G vktgf."Iwuv"ugrctcvg"vjg"vyq
rctvu0

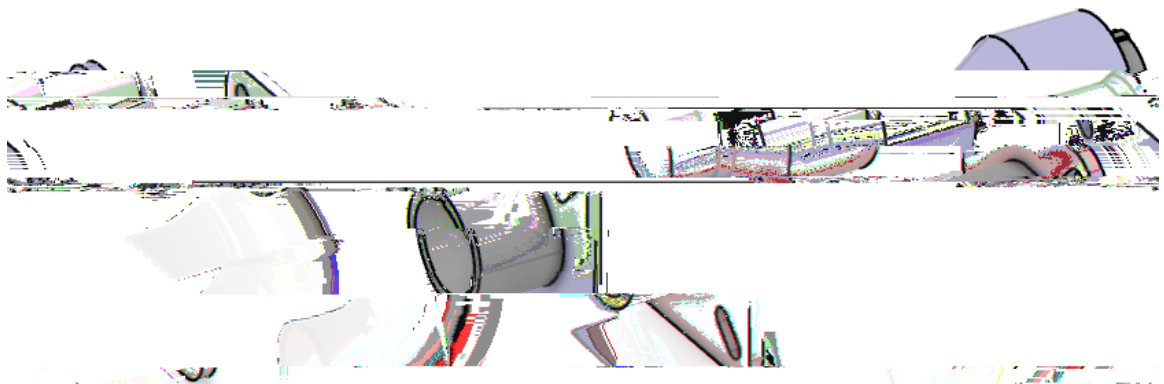

Cv"vjkurqkp. {"qw"ctg"tgcf {"vq" fghkpg" c" dwpfng" dgvy ggp"vjg"vyq"eqppgevqtu0

6 H O H Electrical Branch Geometry L F i " " " K v " k u " n q e c v g f " w p f g t " v j g " (O H F W U L F D O
* H R P H W U " V j g " Electrical Branch Geometry " y k p f q y " c r r g c t u 0

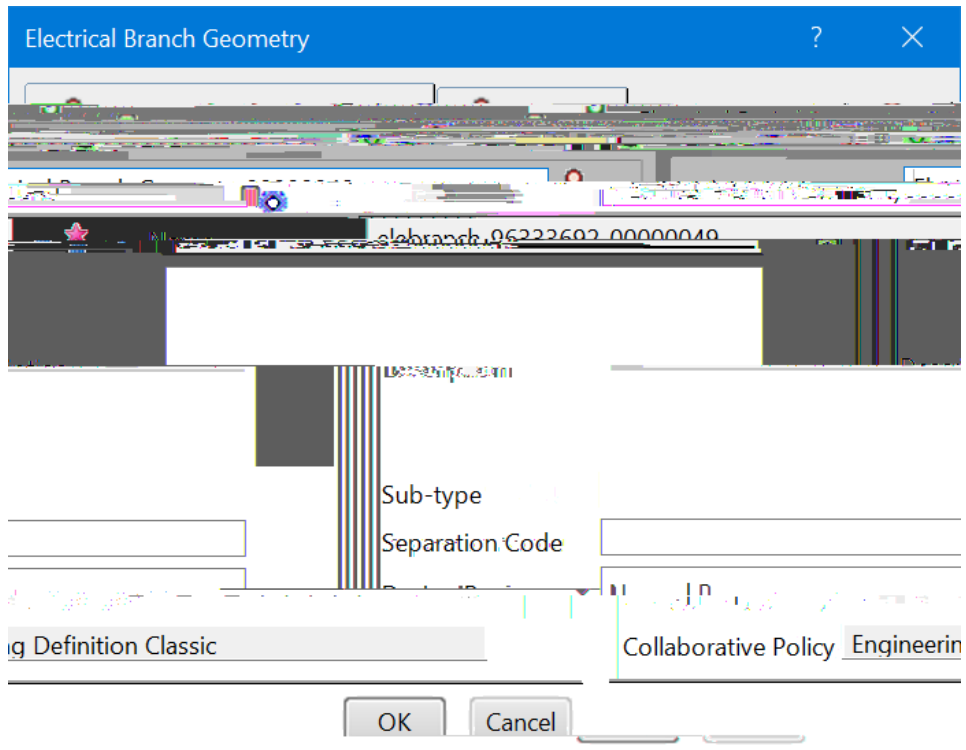

& K D Q J H i t t e W M H R E H (/ (& (O H F W U L F D D Q % U D Q F K F W H R P H W U \

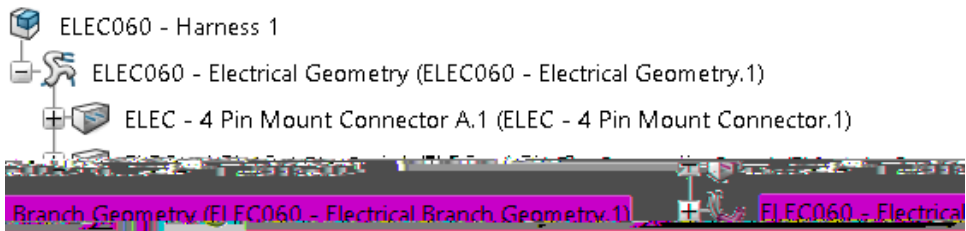

Vjg"Branch Definition" ykpfqy"cnuq"cr rgctu0"

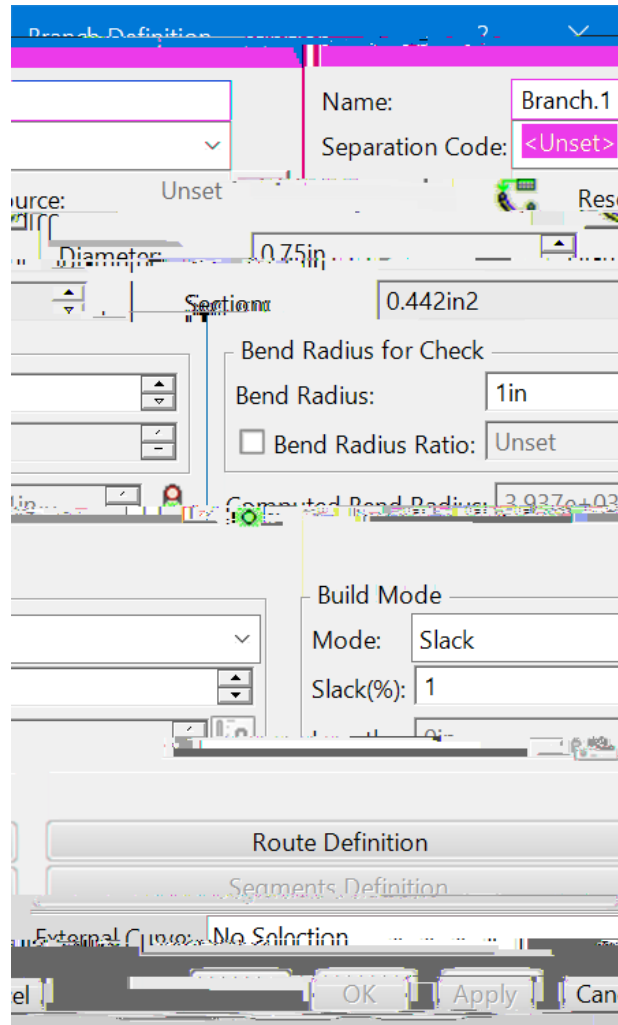

<i>Name</i>	Urgekhhkgu"vjg"pc o g"qh"vjg"dtcpe j
<i>Separation Code</i>	Urgekhhkgu"vjg"ug rctcvkqp"eqfg"xcnwg"hqt"vjg"dtcpe j
<i>Resource</i>	Fkurnc {u"vjg"wpkswg"kf gpvkhkg"ht"vjg"dtcpe j
<i>Diameter</i>	Urgekhhkgu"vjg"qvwukfg"fk c o gvg"qh"vjg"dtcpe j
<i>Section</i>	Urgekhhkgu"vjg"etquu"ugevkqpcn"ctgc"qh"vjg"dtcpe j
<i>Bend Radius</i>	Urgekhhkgu"vjg" o kpk o w o "dgp f"tc fkwu"cnqy g f"ht"vjg"dtcpe j
<i>Bend Radius Ratio</i>	Fghkpgu"vjg"dgp f"tc fkwu"dcug f"qp"vjg"fk c o gvg"qh"vjg"dtcpe j0""C"tcvkq qh"3" yknn"ugv"vjg" <i>Bend Radius</i> vq"vjg"uc o g"uk g"cu"vjg"dtcpe j" <i>Diameter</i> 0

Build Mode

<i>Mode"</i>	
<i>Slack</i>	Dtcpejgu"ctg"eq o r wvgf" y kvj "c" okpk o w o "fkuvcepeg."cpf vjgp" c" r gtegpvc i g"qh"uncem"ku"cf fgf"vq"vjg"dtcpej
<i>Length</i>	Dtcpejgu"ctg" c"ugv"ngpi vj. "tgi ct fnguu"qh"vjg" c o qwpv"qh uncem
<i>Bend</i>	ECVKC" yknn"eq o r wvg"vjg" okpk o w o "ngpi vj" rquukdng y jkng"tgur gev kpi "vjg" <i>Bend Radius</i>
<i>Straight Bend</i>	Ugi o gpv"ngpi vj "eqttgurqpfu"vq"vjg"rcvj" fghkpgf" d{ cteu"qh"ektengu"qh"hkzgf"tcfkwu"cpf"uwtcki jv"nkpgu" i qkpi vj tqw i j "r qkpvu0"
<i>Cornered Polyline</i>	Ugi o gpv"ngpi vj "eqttgurqpfu"vq"vjg"ujqtvguv"rcvj fghkpgf" d{ "cteu"qh"ektengu"qh"hkzgf"tcfkwu"cpf"nkpgu0 Vjg"ewtxg"fqgu"pqv"i q"vj tqw i j "vjg"r qkpvu. "gzegrv"kh"vjg dgpf"tcfkwu"ku"gs wcn"vq" gtq0"Vcpi gpe{ "cv"tqwvg"r qkpvu ku"ki pqtgf0
<i>Slack (%)</i>	Fghkpgu"vjg" r gtegpvc i g"qh"uncem"dgvy ggp"eqppgevkqp"r qkpvu0" Cnvj qw i j "2 ' "ku"cnqy g f. "vjgtg"pggfu"vq"dg" c"uncem"qh"cv"ngcuv 03 ' "vq"cxqkf"wr fcvg"gttqtu" y kvj " J ctpguu"Hncvvgpkpi "vqqnu0
<i>Length</i>	Fghkpgu"vjg"ngpi vj "qh"vjg"dtcpej" y jgp"kp" <i>Length</i> o qfgl""Vjg ngpi vj " o wuv"dg"cu"nqpi. "qt"nqpi gt"vjcp"vjg"fkuvcepeg"dgvy ggp vjg"v y q"eqppgevkqp"r qkpvu0
<i>Route Definition"</i>	Fghkpgu"vjg"dtcpej"tqwvg
<i>Segments Definition</i>	Cnnqy u" hqt"vjg"dtcpej"vq"u y cr"ukfgu"qh" c"uwthceg"vjcv"ku"cvcejgf"vq vjg"dtcpej
<i>External Curve</i>	Cnnqy u"ugngevkqp"qh" c"ewtxg"vq" fghkpg"vjg"dtcpej"tqwvg
	Ocp{ "qh"vjgug" rctc o gvgtu" y knn"dg"vguvgf"hwvtv jgt"qpeg"vjg"tqwvg"ku" fghkpgf0"
	& K D Q J W W K M R + D U Q H V "W jku" y % U D Q F K pc o g" hqt"vjg"dtcpej0"
	8 Q O H V V D O U H D G D U M W R K D Q U W K H V J G " Section " y knn cwwq o cvkecn { "ejcpi g"vq"203 ; 8kp40""Vjku"ku"fwg"vq"vjg"v y q" hkg nfu"dgkpi "eq o r wvgf"dcugf"qp gcej"qvjgt0"
	& K D Q J B U R K H U S W R V { L Q n n { . { qwt" dgp f" tcfkwu" y knn" dg" gswcn" vq" qt" i tgcvt vjcp"vjg" fkc o gvg t0" Kh" { qw"ugv"vjg" dgp f" tcfkwu" u o cnngt"vjcp"vjg" fkc o gvg t. "ECVKC" y knn" fkurnc { cp"gttqt" o guuci g"cdqvw"vjg" k o rtcevkecnkv { "qh"vjku0"

& K D Q J **Build Mode** **Slack** D Q G **Slack** S M K I F H Q W D V j k H y k W j R x g " c m
v j g " d t c p e j " q r v k q p u " f g h k p g f 0 " " P q y " v q " i g p g t c v g " v j g " d t c p e j " x k c " v j g " t q w v g " f g h k p k v k q p 0

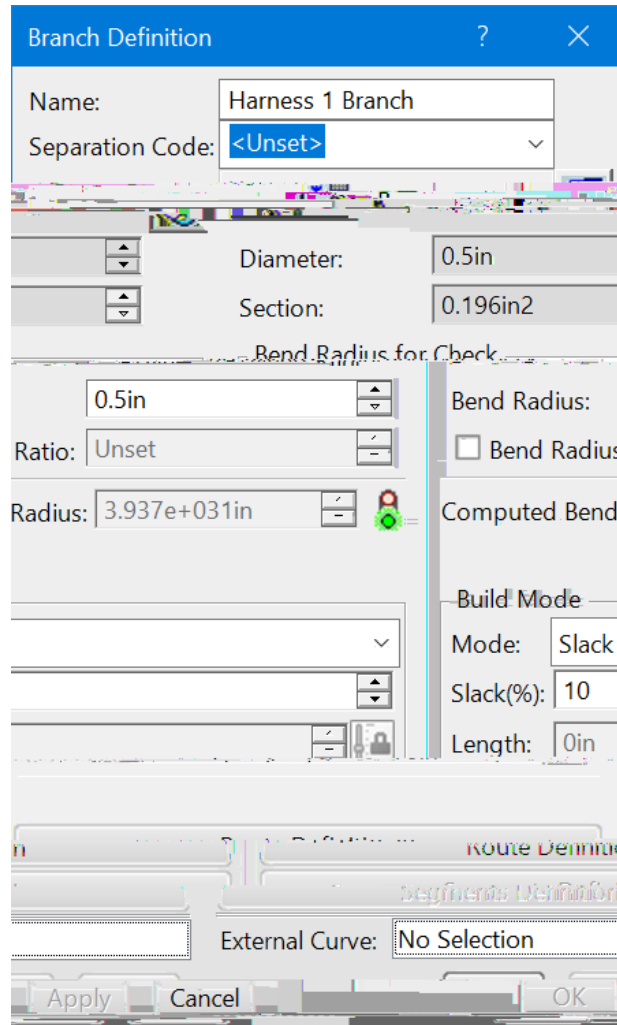

6 H **Route Definition** "Vjku"yknn"cnny" {qw"vq" fghkpg"vjg"tqwvg" hqt"vjg" dwpfng0""Vjg"Route
 Definition" ykpfqy" yknn" fku rnc {0""Vcmg" c" swkem" nqqm" cv"vjg" xctkqu" qrvkqu" kp"vjg"Route
 Definition" ykpfqy0"

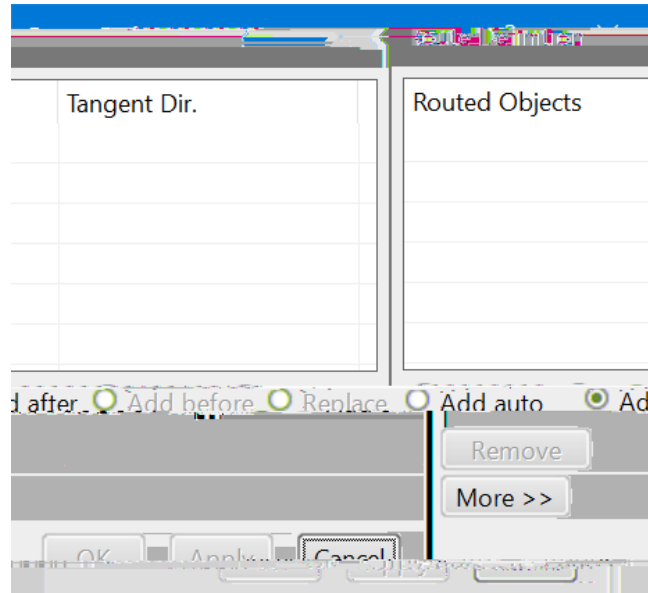

- Routed Objects / Tangent Dir.* Fku rnc {u"vjg" qdlgevu" cpf" rkpvu" hqt"vjg" tqwvg" fghkpvkqp
- Add after* Cf fu" rkpvu" cpf" eqppgevkqp" rkpvu" chvgt"vjg" ugngevgf rkp
- Add before* Cf fu" rkpvu" cpf" eqppgevkqp" rkpvu" dghqtg"vjg" ugngevgf rkp
- Replace* Tgrncegu"vjg" ugngevgf" rkp" ykvj" cpqvjgt" ugngevkqp
- Replace* Tgrncegu"vjg" ugngevgf" rkp" ykvj" cpqvjgt" ugngevkqp
- Add auto* Cwvq o cvkecm { "qtfgtu"vjg" tqwvg" ugngevkqu" dcugf" qp vjgkt"v { rg

D{"ugngevkpi "v j g"More>> dwvvpq."{qw"i gy"c"hg y"cf fkvkqpcn"qrvkqpu0"

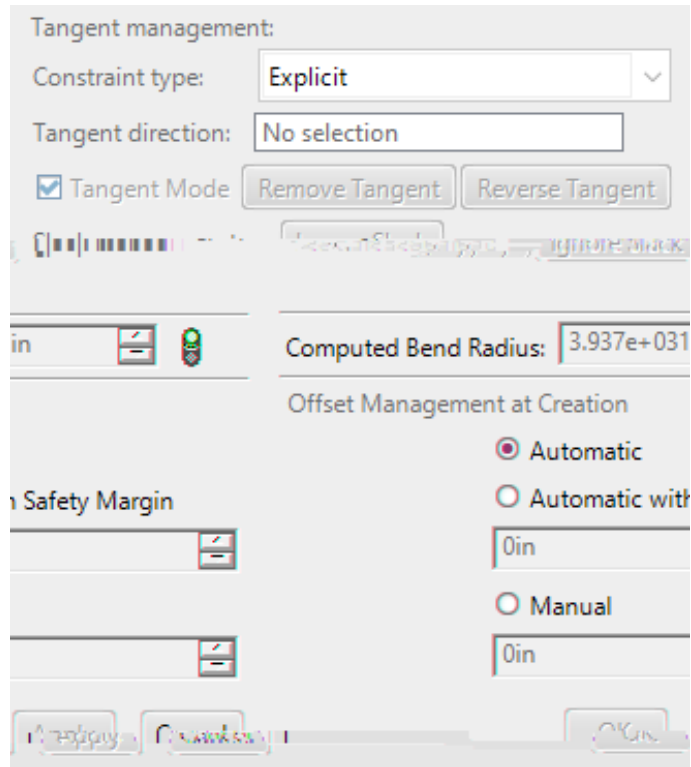

Tangent management

<i>Constraint type</i>	Fghkpgu"v j g"v{ rg"qh"vcp i gpe{"vq"dg"fghkpgf
<i>Explicit</i>	Vcp i gpe{"ku"fghkpgf"xc"o c p w c n"xgevt"fghkpvkqp0" Vcp i gpe{"fghkpvkqp"ku"fghkpgf"v j tqw i j"t k i j v"enkem"kp v j g" <i>Tangent Direction</i> "hkgnf0
<i>From curve</i>	Vcp i gpe{"ku"fghkpgf"htq o "c"ewtxg"qt"nkpg"ugngevkqp0" Y j gp" <i>From curve</i> "ku"ugngevgf."v j g" <i>Tangent direction</i> ejcpi gu"vq" <i>Element</i> 0"

Slack management K i p q t g u " q t " t g o q x g u " u n c e m " d g v y g g p " r q k p v u

Offset Management at Creation

<i>Automatic</i>	Nc {u"v j g"dwp fng"qp"v j g"uwthceg
<i>Automatic with...</i>	Nc {u"v j g"dwp fng"qp"v j g"uwthceg"y kv j "cp"cf fkvkqpcn"qh hugv"qh"v j g uchgv{"o c t i k p"fkuvcepg
<i>Manual</i>	Cnnq y u {"qw"vq"urgek h{"c"urgek hke"fkuvcepg" hqt"v j g"dwp fng"vq gzkuv"qh"v j g"uwthceg

Pqy {"qw"ctg"tgc f{"vq"fghkpg"v j g"tqwvg0"

6 HOHFW WKH 3 LQ "PRXQW & RQQHFW Rn{"c ffgf"vq"vjg
Route Definition" ykpfaqy."cu" ygm"cu"vjg"ugi o gpv"eqppgevkqp" rkp"ku"cwvq o cvkecn {"fghkpgf0



Cp{vk o g" {qw"ugnev"cp"gngevtkecn" fgxkeg" ykvj "c"ugi o gpv"eqppgevkqp" rkpv."vjg"eqppgevkqp
rqp" ykm"cwvq o cvkecn {"dg"ugngevgf"cpf"vjg"vcp i gpv" fktgevkqp" ykm"cwvq o cvkecn {"dg" fghkpg f
kp"vjg"Initial Condition fktgevkqp" fghkpgf"kp"vjg"ugi o gpv"eqppgevkqp" rkp"vøu" rnceg o gpv
eqpvtckpvu0"

6 HOHFW WKH 3 LQ "PRXQW & RQQHFW Rn{"c ffgf"vq"vjg"tqwgf"qdlgevu0"
Pqkeg"vjg"dwpfng"ku"pqy" rtgugpv0"

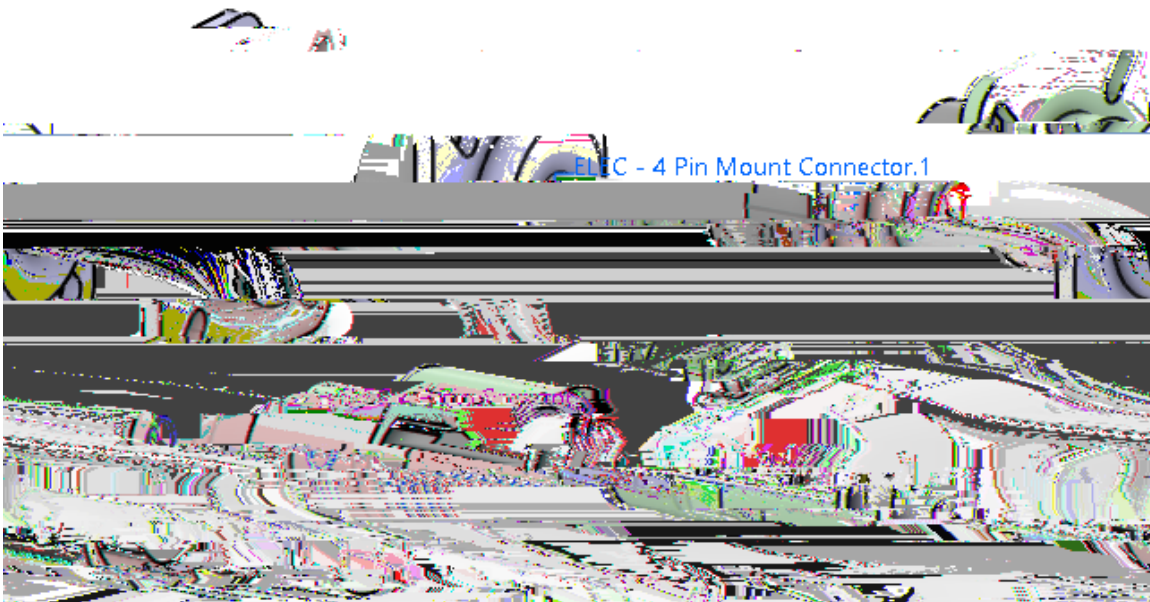

Note: The physical shape of the branch may vary based on the position of the two connectors."

6 H O O K F W R R ~~W~~ ~~K~~ ~~H~~ ~~D~~ ~~e~~ ~~f~~ ~~i~~ ~~n~~ ~~i~~ ~~o~~ ~~n~~ ~~0~~ Definition Z L Q G V R Z y knn"vcmg" {qw"dcem"vq"vjg"Branch
Definition0"

6 H O O K F W R R ~~W~~ ~~K~~ ~~H~~ ~~D~~ ~~e~~ ~~f~~ ~~i~~ ~~n~~ ~~i~~ ~~o~~ ~~n~~ ~~0~~ Definition Z L Q G V R Z dtcpej "ku" fghkpgf0"

Pqvkeg"vjcv" {qw"ctg"uvknn"kp"vjg"Gngevtkecn"5F"Rctv" Fgukip" y qtm dgpej0"

6 H O H ~~E~~ ~~X~~ ~~I~~ ~~T~~ ~~W~~ ~~K~~ ~~R~~ ~~I~~ ~~Q~~ "Vjku" y knn"vcmg" {qw"dcem"vq"vjg"Gngevtkecn"5F" Fgukip" y qtm dgpej

Pqvkeg"cv"vqqndct"er r gctu"kp"vjg"f kurnc{"cu"y gmn0



\$ X W R 5 R X W L Q J 0 R G H f kurnc{"u"vjg"ugngev"dtcpej"nqecvkqpu"qp"vjg"hn{"hqt
tqwvkpi"vjg"dtcpej0



5 R X W H R Q % U D Q F K 3 R L Q W j " r q k p v " c p
g z k u v k p i " d t c p e j



5 H P R Y D O 0 R G H T g o q x g u " d t c p e j " r q k p v u



& U H D W L R Q 0 R G H f kurnc{"u"vjg"etgcvkqp"qrvkqpu



\$ G G 6 W D Q G D U G % U D Q F K 3 R L Q W j " r q k p v " c p
g z k u v k p i " d t c p e j



\$ G G \$ V V R F L D W L Y H % U D Q F K 3 R L Q W j " r q k p v " c p
g z k u v k p i " d t c p e j



\$ G G 3 U R W H F W L Y H & R Y L U Q O g " e q x g t k p i " v q " c " d t c p e j



6 S O L W % U D Q F K U r n k v u " c p " g z k u v k p i " d t c p e j



7 U D Q V I R U P 0 R G H f kurnc{"u"vjg"vtcpuhqt o"qrvkqpu



7 U D Q V O D W H % U D Q F K t c p u n c v g u " c " d t c p e j



' H W D L O H G 3 U R I L O H 0 P D O D J H R H Q W j " d t c p e j

& K D Q J ~~Dian~~ ~~Wen~~ H W R Slack ~~W~~ M R D ~~Be~~ ~~Gl~~ ~~R~~ ~~W~~ ~~K~~ ~~u~~ H W R "" P q y " { q w " c t g
t g e f { " v q " t q w v g " v j g " d t c p e j 0 ""

0RYH \RXU PRXVH RYHU WKH 3LQ 0R XIQPH & RVQQRH & WRFUWD
WKDW DSRHDLFH D \HOORZ VSKHUH DSSHDUV DW WKH FR

\$Q\WLPH \RX VHOHFW D VHJPHQW FRQQHFWRU & SWRQVW
VHOHFWHG DQG WKH WDJJHQW GEULFH & WLFHQW LOO DXWRP
GLUHFWRU GHILQH LQ WKH VHJPHQW FRQQHFWRU
6HOHFW WKH VHJPHQW FRQQHFWRU & SWRQVW
GHILQH LQ WKH URXWHG REMHFW 1RWLFH WKH EXQG

Note: The physical shape of the branch may vary based on the position of the two connectors.

6HOHFW LQKHS & BQFK LV FRPSOHWHG

6HOHFWLWFRQ 7KLV ZLOO WDNH \RX EDFN WR WKH (OHFW
DQG DFWLYDWH WKH HOHFWULFDO JHRPHWU\ EUDQFK

6DYH \RXU KDUQHVVWV & SWLRQV ZRXOG EH DRJURG RSW
EXQGOHV /HDYH \RXU KDUQHVVWV & SWLRQV ZLOO EH XVH

Defining Multi-Branches

Cnvjqwi j "ukping" dtcpejgu"ctg"xgt{"wughwn" hqt"uk o rng" i gq o gvtke" dwpfngu." {qw" y knn" qhvgp" hkp f vjcv" {qw" ctg" pqv" cdng" vq" etgcvg" vjg" pgeguuct {"dwpfngu" y kvj" lwuv" c" ukping" dtcpej0" "Vjg" o quv eq o o qp" v {rg" qh" dwpfng" wugf. "gxgp" hqt" c" uk o rng" uvtcki jv" i gq o gvtke" dwpfng. "ku" c" o wnvk/ dtcpejcdng0"

2 S H Q **ELEC080 - Multi-Branchable** G R F X P [H Q W "etgcvg" c" o wnvk/ dtcpejcdng fqw o gpv" qh" c" uk o rng" jctpguu" qh" vj tgg" eqppgevqtu" kp" c" õ [ö" eqphk i wtcvkqp0"

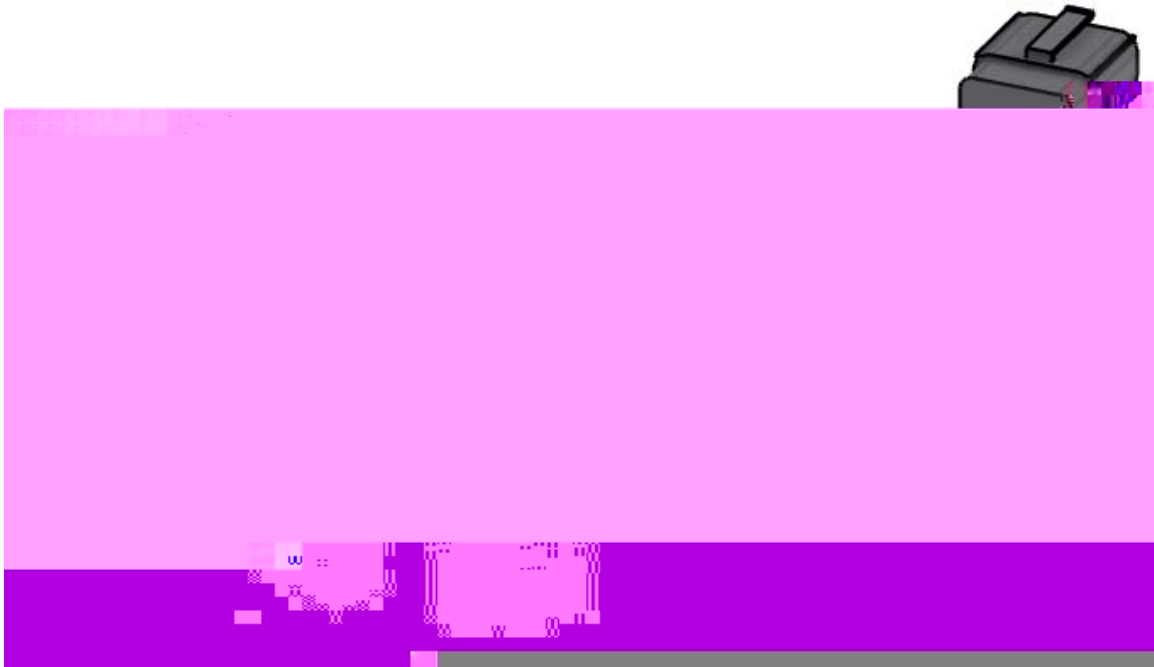

, I Q R W D O U H D G \ V K K I H (O H F W Z L M F F D O W ' R ' F W g h k p k Q " c ' Z R U N E H dtcpej" kpkvkcn {"ku" i qkp i "vq" dg" pq" fkhgtgpv" vj cp" c" ukping" dtcpej0"

6 H O H **Electrical Geometry** L F R Q W K H **ELEC080 - Multi-Branchable** SURG  Wjg" Electrical Geometry" ykpfqy" crrgctu0"

& K D Q J **Fit** W M V R _ E H (/ (& (O H F W D I Q F D O K * O H F W W i g t c u" ujqyp0"

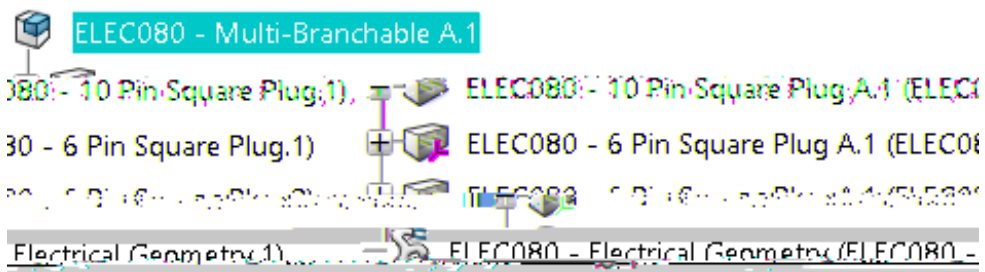

Kp"vjku" ecug." {qw" y knn" o qxg" cnn" qh" vjg" eqppgevqtu" kpvq" vjg" gngvtkecn" i gq o gvt {"uq" vjg" gpvktg vj kpi" y knn" dg" ugnh" eqpvckpgf0"

'UDJ HDFK RI WKH F ELEC080 - Electrical Geometry "WuKqmf"errgct
cu"ujqyp"y jgp"{qw"ctg"hkpku jgf0

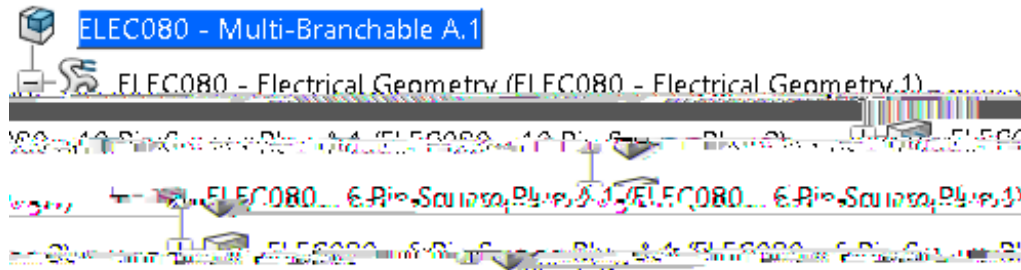

Cv"vjku"rqkp."{qw"ctg"tgcf{"vq"fghkpg"vjg"dtepej"ugi o gpv0

\$ F W L Y ~~ELEC080 - Electrical Geometry~~ "

6 H O H ~~Electrical Branch Geometry~~ L F "Vjg"Electrical Branch Geometry
y k p f q y "c r r g c t u 0

. H \ L Q (/ (& (O H F W U L F D O I % U T W K E H Q G H V R O M V L Y M n
u v c t v " c " d t c p e j 0

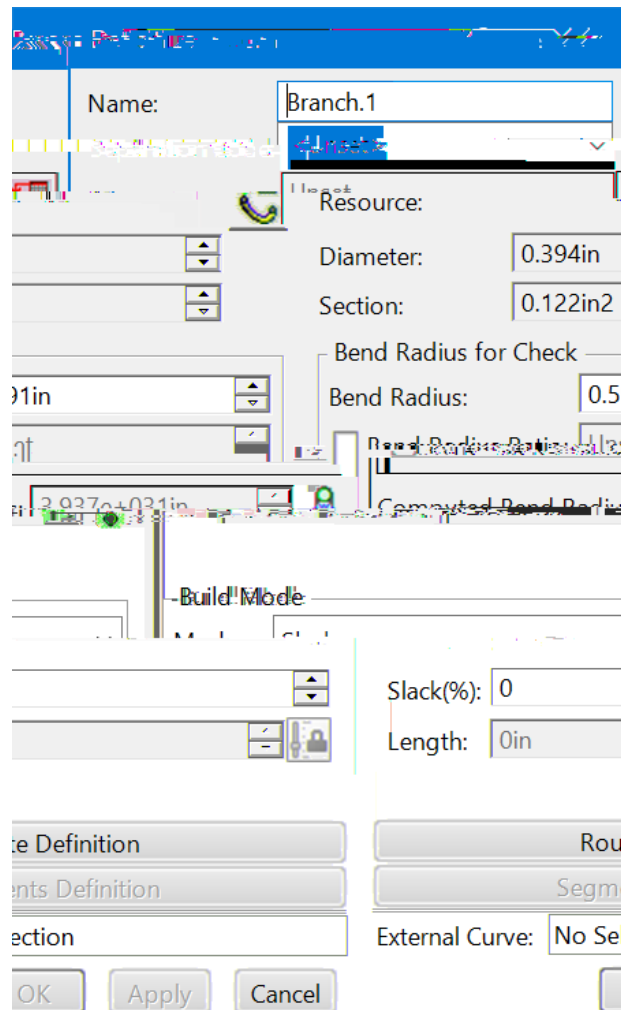

& K D Q J ~~W~~ ~~K~~ H I W K H E U D Q F K W R ~~Q~~ ~~D~~ ~~L~~ ~~O~~ ~~J~~ ~~%~~ ~~U~~ ~~D~~ ~~O~~ ~~F~~ ~~K~~
dtepej" {qw"ctg"iqkpi"vq"etgcvg0"

& K D Q J ~~D~~ ~~i~~ ~~a~~ ~~n~~ ~~e~~ ~~k~~ ~~e~~ ~~r~~ H W R L Q ~~B~~ ~~e~~ ~~n~~ ~~e~~ ~~d~~ ~~i~~ ~~n~~ ~~s~~ ~~K~~ ~~M~~ ~~R~~ C i k ~~Q~~ "k"ku"e"iqqf"twng"qh
vjw od"vq" ocmg"uwtg"vjcv" {qwt"dgpf"tcfkwu"ku"nctigt"vjcp" {qwt"dtepej"fk o gvg0"

: L W K W K H

6 HOH Segment Connection Point WH[W WR EHJLQ WKH URXWH DQG WKH
VTXDUH SOXJ DV VKRZQ



6 HOHFW WKH FRQQHFWRQ SRVW LQ WKH FRQWUXXU SLQ VTXDUH S



6 H OOF W cvkeg"pc y

1

1 – Segment Definition

Vjku"ctgc"cmnqyu" {qw"vq"xkgy"vjg"xctkqwu"ugi o gpvu"kp"c
o wnvk/dtcej

([L W V % U D Q F K 3 R L Q W v j g " d t c p e j " r q k p v " k p " c " d w p f n g



5 H P R Y H % U D Q F K 3 R L Q W v j g " d t c p e j " r q k p v " k p " c " d w p f n g

<i>Name</i>	Urgekhhkgu"vjg"pc o g"qh"vjg"ugi o gpv
<i>Color</i>	Urgekhhkgu"vjg"eqnqt"qh"vjg"ugi o gpv
<i>Resource</i>	Fkurnc{u"vjg"wpkswg"kf gpvkhkg"ht"vjg"ugi o gpv
<i>Profile Type</i>	Urgekhhkgu"vjg"ujcrg"qh"vjg"ugi o gpv
<i>Section Parameters</i>	Urgekhhkgu"vjg"uk g"ejctcevgtkuvkeu"qh"vjg"ugi o gpv
<i>Section Area</i>	Urgekhhkgu"vjg"etquu"ugevkqp"ctgc"qh"vjg"ugi o gpv0""Kv"ku nkpmgf"vq"vjg"Section Parameters."uq" o qfkh{kpi"qpg yknn"wr fcvg"vjg"qvjgt
<i>Detailed Profile Management</i>	Cnmq yu" o qtg"kp" fgrvj" o qfkhkecvkqp"qh"vjg" r tqhknгу cnqp i"vjg"ugi o gpv
<i>Extremity Management</i>	
<i>Start point</i>	Fghkpgu"vjg"tcvkq"qh"vjg"ewtxg"vjg"dtcpej" r qkp v"uvctvu
<i>End point</i>	Fghkpgu"vjg"tcvkq"qh"vjg"ewtxg"ngpi vj"vjg"dtcpej" r qkp v gpfu
<i>Visualization Management</i>	
<i>Reframe on Selection</i>	Tghtc o gu"cpf"hkvu"vjg"dwpfng"ugi o gpv"kp"vjg"fkurnc{ Cv"vjku"r qkp v."{qw"ctg"tgcf{"vq" fghkpg"vjg"dtcpej" r qkp v0"
	& K D Q J K o l w k w R O L J w E o j x H qh"dnwg"ku"pqv"ko r qtvcpv."{qw"lwuv"ycpv"vq ugg"vjcv"vjg"eqnqt"qh"vjg"dwpfng"ecp"dg"ejcpi g f0"
	Pqy"vq"cff"c"dtcpej" r qkp v0"

6HOHF\$G VDH%UDQFLFBRLOQV\FH \RX VHOHFW WKH LFRQ W
XQWLO \RX VHOHFW WKH EXQGOH SRLQWQLO \RX ZDQW WF

6HOHF&K DQJH 5HIHUHQEFRRZEDS VHOHFW WKH V\PERO QI
VTXDUH SOXJKLV ZLOO VZLWFK VLGHV RI WKH UHIHUHQFI

\$W WKLW SRLQW \RX QHHG WR GHWQWPGQHLQRZ \RQ ZDQ
DVVXPH \RX ZDQW WKH EUDQFK SBLZOWIGRFLQKH DSDHW
FRQQHFWRU

6 H O H ~~EXT~~ WKRIQ ZKHQ "G R Q H"urnkv"vjg"dtcpej"kp vq"vyq"ugi o gpvu0"
Pqvkeg"vjg"ugi o gpvu"ygtg"tgpc o gf"dcem"vq"vjg"fgbcwv"pc okpi "uejg o g0"

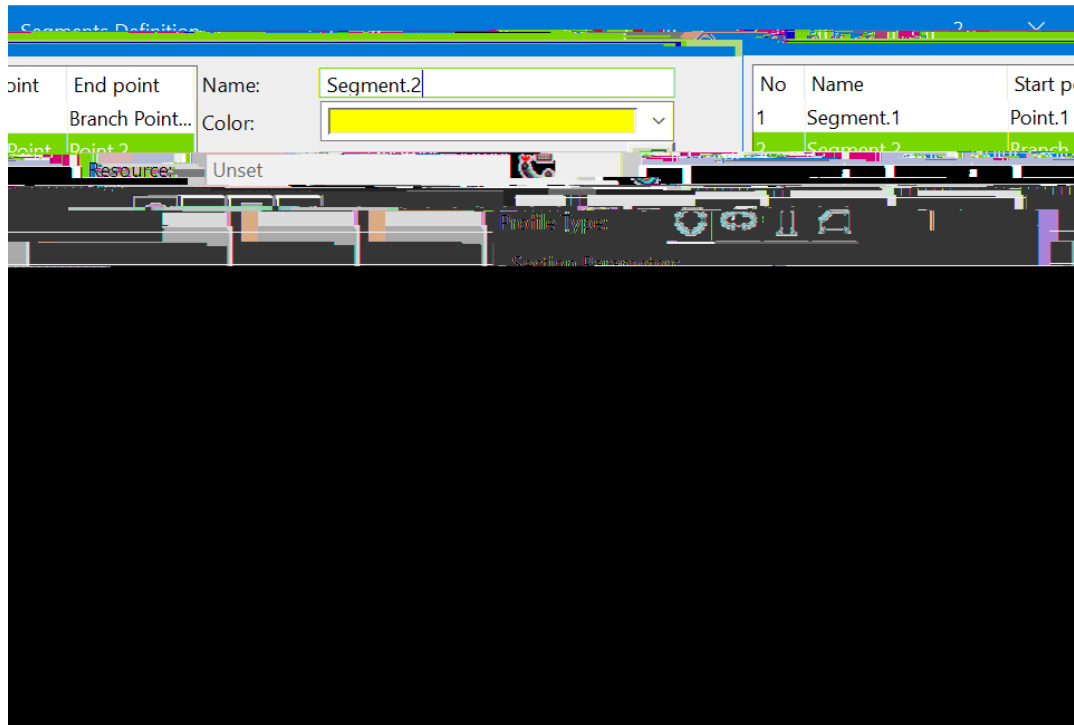

:LWK WKH ILUVW VHJPHQW VHOH ~~Ext~~ WKRIQ HVR QHVR ZLQGRZ F
jgnr" {qw"mggr"vtcem"qh"vjg"xctkqwu"ugi o gpvu0"

Cnuq."pqvkeg"vjg"uvctv"cpf"gp f"rqkpvu"kp"vjg"Extremity Management0""Vjgug"xcnwgu"ctg"pqy
ceeguukdng"vq"cf lwuv"vjg"uvctv"cpf"gp f"nqecvkqpu"qh"vjg"ugi o gpvu0"

6 H O ~~Segment.2~~ DQG F K D ~~Di~~ WKRI " [qv" Qc {"pggf"vq"ugngev"Apply"vq
igv"vjg"dwpfng"vq"wr fcvg"rtqrgtn{0"

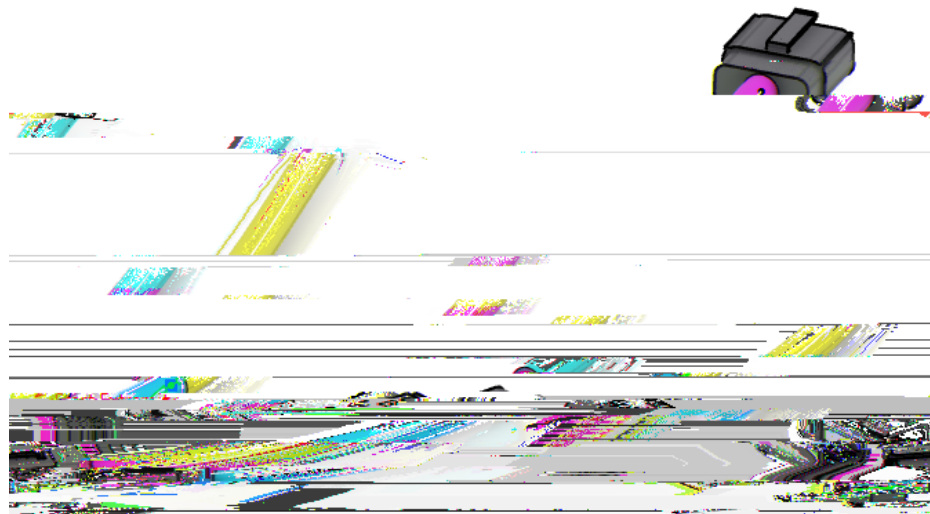

6 H O ~~Ext~~ WKRIQ ~~Segments Definition~~ ZLQGRZ yknn"jcxg"vjg"pgy"ugi o gpvu" fghkpgf0"

6 H O K F W R B M k H Definition Z L Q G V R k Z y k n n " e t g c v g " v j g " d t c p e j 0 "

6 H O H C l a s s i c B r a n c h D e f i n i t i o n L F I U " " V j k u " y k n n " c n n q y " { q w " v q " e t g c v g " c " p g y d t c p e j " y k v j k p " v j g " g z k u v k p i " d t c p e j " u g v 0 "

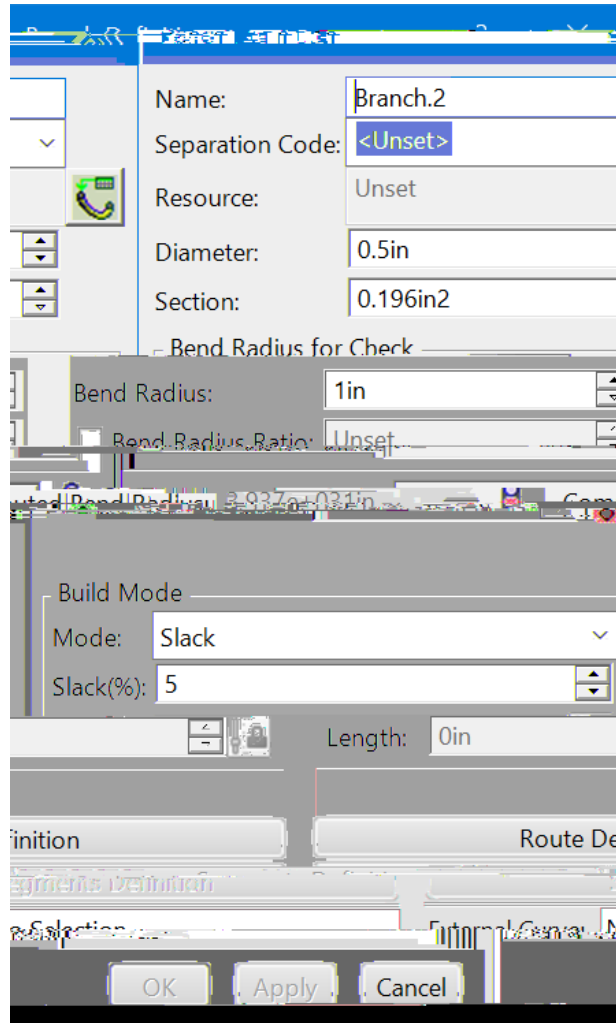

& K D Q J W a n e W R H 6 L G H % M K D H O F D N a m e W R H P q l y Q q w " c t g " t g c f { v q " f g h k p g " v j g " t q w v g " h q t " v j g " u k f g " d t c p e j 0 "

6 H O R o u t e D e f i n i t i o n C v " v j k u " r q k p v . " { q w " e c p " u g n g e v " c p { " q h " v j g " e q p p g e v q t u " q t " d t c p e j r q k p v u " v q " u v c t v " v j g " t q w v g 0 " " Y j g p " { q w " u g n g e v " c " d t c p e j " r q k p v . " v j g " u g i o g p v " { q w " u g n g e v " y k n n " j g n r f g v g t o k p g " y j c v " g z v t g o k v { " v j g " d t c p e j " y k n n " c u u q e k c v g " v q 0 "

6HOHFw WKH \HOORZ PxoGqH"cpHduWdyhpWg"0pffW"

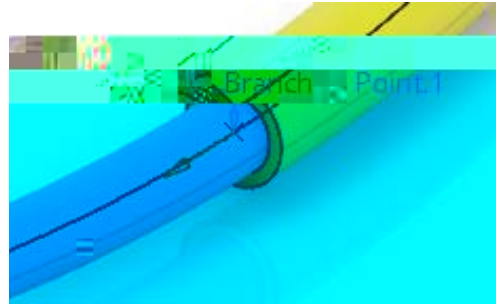

6HOHFw WKH RWKHU jku"ySmLo"vYgTxpDjU H SOXJ

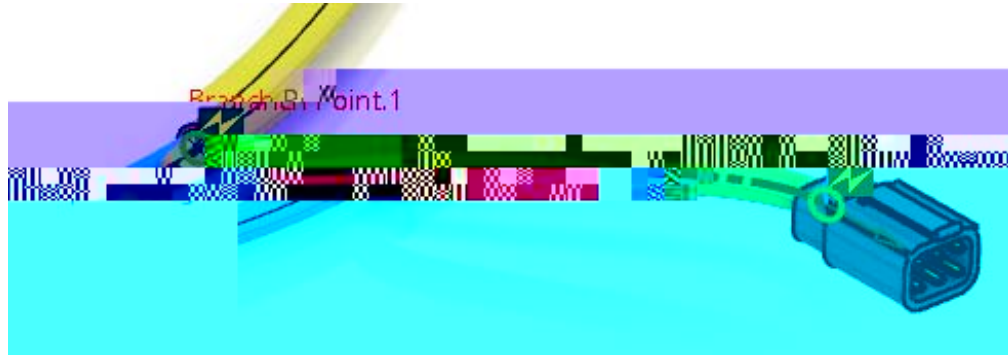

Nqqm"enqugn{"cv"vjg"urgekhecvkqp"vtgg0"

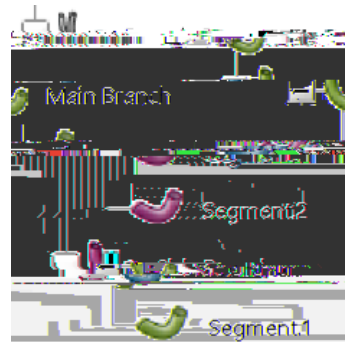

Vjg"pgy"dtcpej"jcu"cp"gzenc"ocvkqp"rqkpv"ykvj"c{"gmnqy"qxcn"ctqwpf"kv"vq"kpfkcev"vjcv"vjg
dgpf"tcfkwu"okijv"pqv"jcxg"dggp"tgurgevfg0"Vjku"ku"pqv"c"etkvecn"gttqt."dwv"kv"ku"uq"ogvjkpj
{qw"yknm"ycpv"vq"ycvej"ht"yjgp}{qw"kpuvcmn"vjg"jctpguu"kpqv}{qwt"cuug"odn{0"Kh}{qw"hkpf"vjcv

6 H OOKF WR BmKkH Definition Z L Q GVRkZ yknn"jcxg"vjg"pgzv"dtcej" fghkpgf0"Kv
ujqwnf"cr rget"cu"ujqyp0

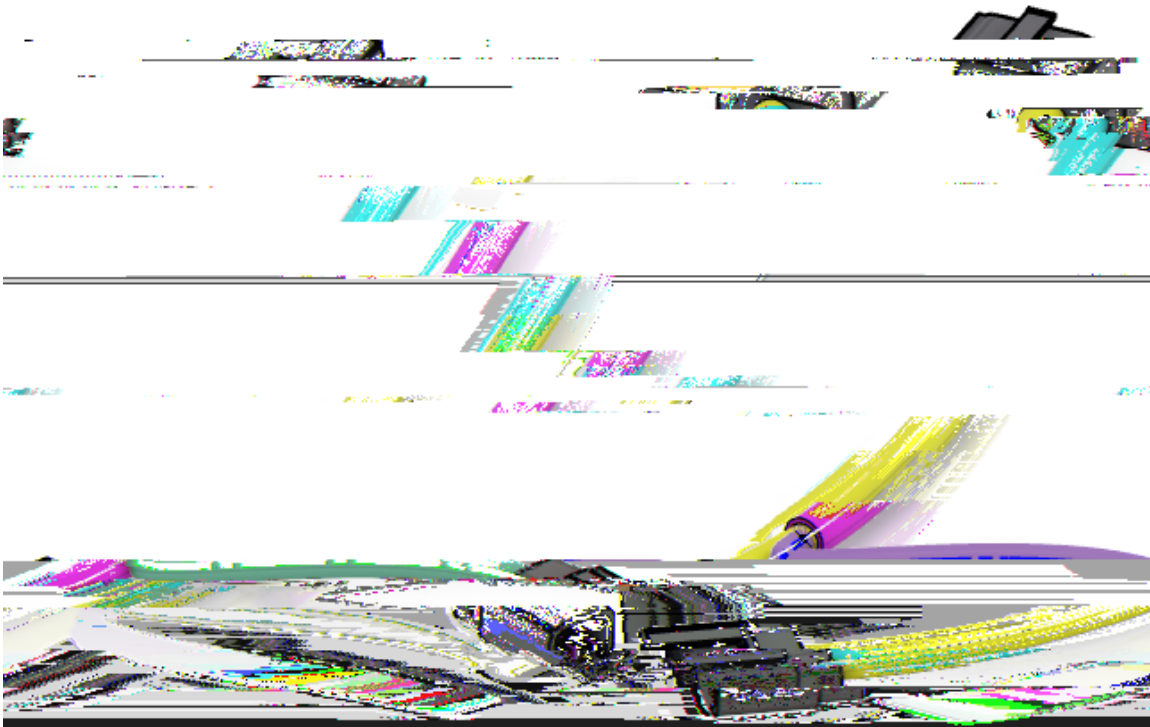

6 H O H Ext WKRIQ WR U H W XULG DOR W'KIN L(CQ ZW'U N E H Q F K

' H O H WEBC080 Electrical Branch Geometry IURP W K[hw"Wkn"Uhg"vjg
ucog"jctpguu"wukpi"vjg"ko ogtukxg"qrvkqpu0

6 H O H Electrical Branch Geometry L F"U"Vjg"Electrical Branch Geometry
ykpfaq"cr rgetu0

. H \ L Q (/ (& (O H F W U L F D O I P % U T W K E H Q G H V R O M V U W
uvtv"c"dtcej"cpf"vjg"Dtcej" Fghkpkvq"ykpfaq"cr rgetu0

6 H O CdrFcaW"

6 H O H ~~Wire~~ ~~Branch~~ ~~Definition~~ L F"1 ""Vjg"Branch Properties"y kpfqy
crrgctu0

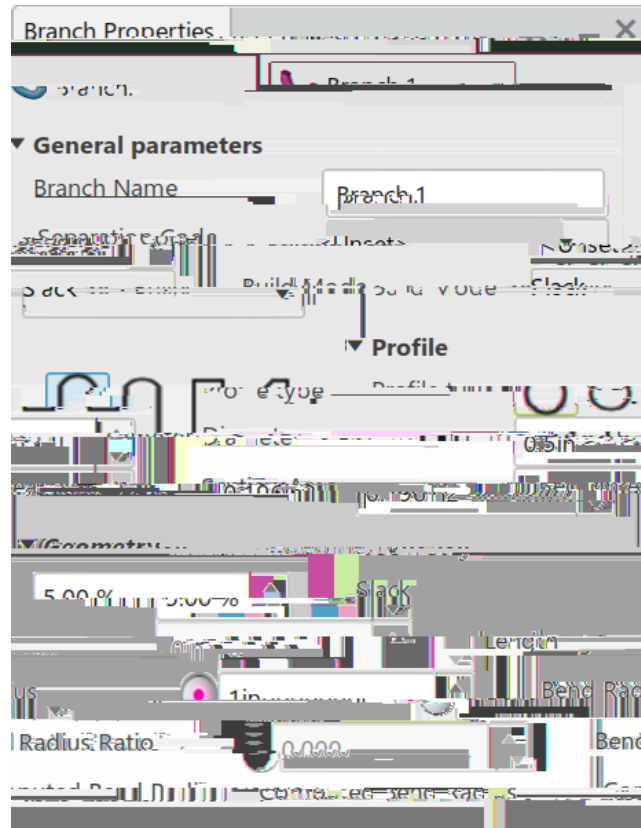

& K D Q J ~~Name~~ K R H W K H E U D Q F K W R ku"0 k"lg"Qjg%ld D Q F k
dtepej" {qw"ctg"iqkpi"vq"etgcvg0"

& K D Q J ~~Diameter~~ H W R L Q ~~Bend Radius~~ K M R C i k p "kv"ku"e"iqqf"twng"qh
vjw od"vq"o cmg"uwtg"vjcv" {qwt"dgpf"tcfkwu"ku"nctigt"vjcp" {qwt"dtepej"fkco gygt0"

: L W K ~~Build Mode~~ V H ~~Slack~~ R V H ~~Slack~~ & H U F H Q W D J H W R

6HOH Segment Connection Point WH[W WR EHJLQ WKH URXWH DQG WKH
VTXDUH SOXJ DV VKRZQ

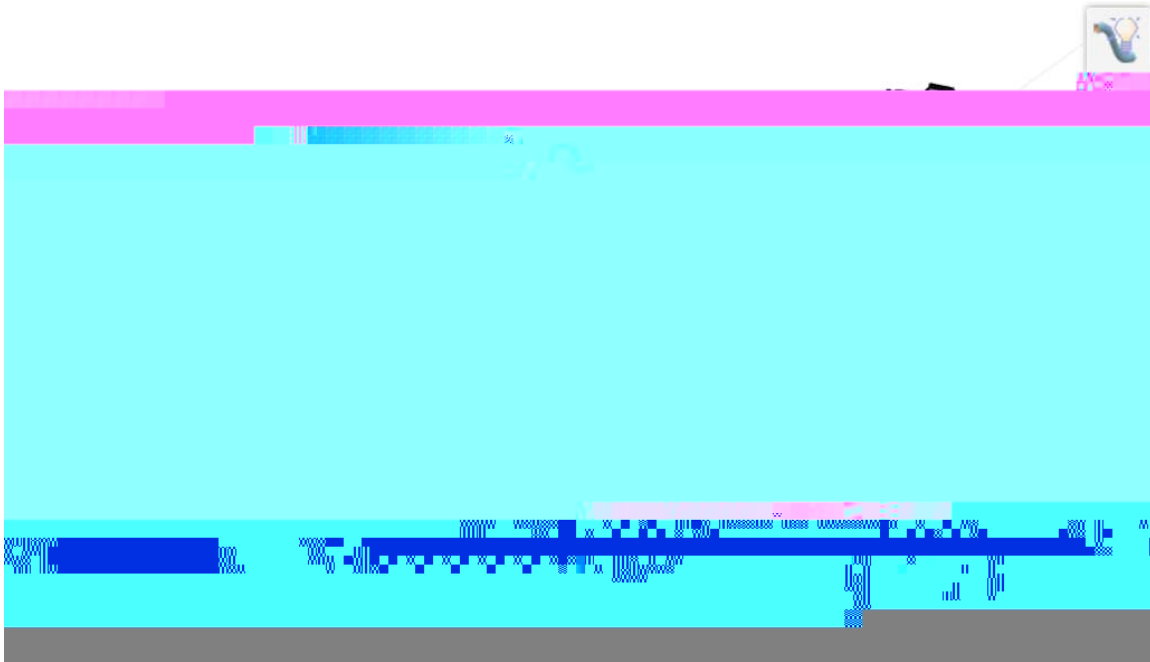

6HOHFW WKH FRQQHFWRQ SRLQW FRUWV WKH SLQ VTXDUH S



Pqvkqy"vjg"Segment.1"vcd"cr rgctu" ykvjpk"vjg"Branch Properties" ykpfqy0"

6 H O H Segment.k HW Dvj qwnf" cr rgct"cu"ujqyp0

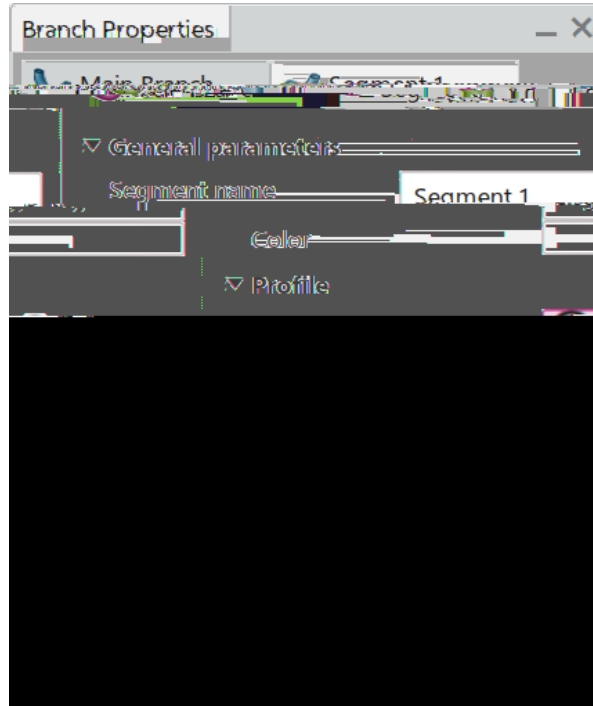

Segment name

Urgekhkgu"vjg"pc o g"qh"vjg"ugi o gpv

Color

Urgekhkgu"vjg"eqnqt"qh"vjg"ugi o gpv

Profile Type

Urgekhkgu"vjg"ujcrg"qh"vjg"ugi o gpv

Diameter

Urgekhkgu"vjg"fkc o gvg"qh"vjg"ugi o gpv

Section Area

Urgekhkgu"vjg"etquu"ugevkqp"ctgc"qh"vjg"ugi o gpv0""Kv"ku
nkpmgf"vq"vjg"*Diameter*

CATIA Electrical Harness Design

8 V H **Change Branch Point Unit** LFRQ LI QHHG HDG StandeR V ZV Lj WFK WR
vgzv"kp"vjg"fkurnc{"ujqwnf"dg"Distance"tcvjgt"vjcp"Ratio0"

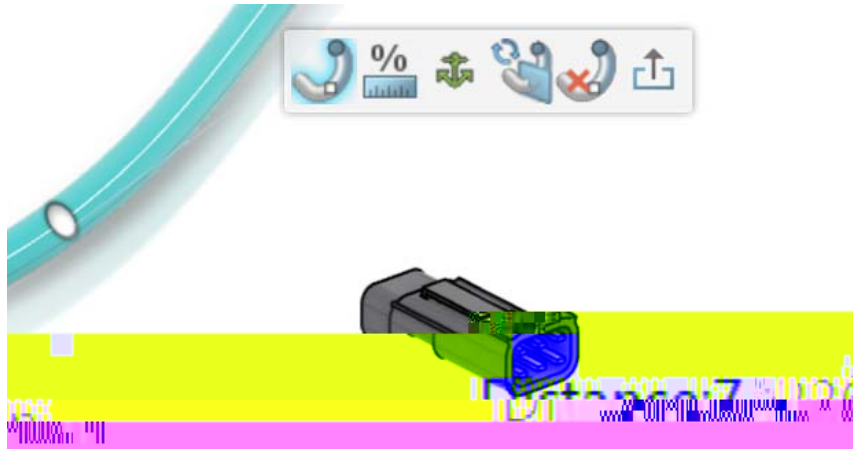

6 H O H **Distance** KW H [W NH \ L Q Enter DVQC G vgl"Q" H F W
8"kpjgu0""Pqy."pq"ocvgt"jqy"nqpi"vjg"igqogvtke"dwpfng"dgeqoguyjgp"{qw"kpucnm"kv."vjg
fkucpeg"vq"vjg"dtgcm"rqpv"ykmn"cnyc{u"dg"8"kpjgu0""Kh"{qw"ygtg"vq"ugv"kv"vq"c"tcvkq."vjgp"vjg
fkucpeg"yqwnf"cfuwv"dcugf"qp"vjg"ngpi"vj"qh"vjg"dwpfng0"

6 H O H ~~EXT~~ WKRIQ ZKHQ "GRUQ"urnkv"vjg"dtcpej"kp"vq"vyq"ugi o gpvu0"
Pqvkeg"vjg"ugi o gpvu"ygtg"tgpc o gf"dcem"vq"vjg"fghcwnv"pc okpi "ue jg o g0"

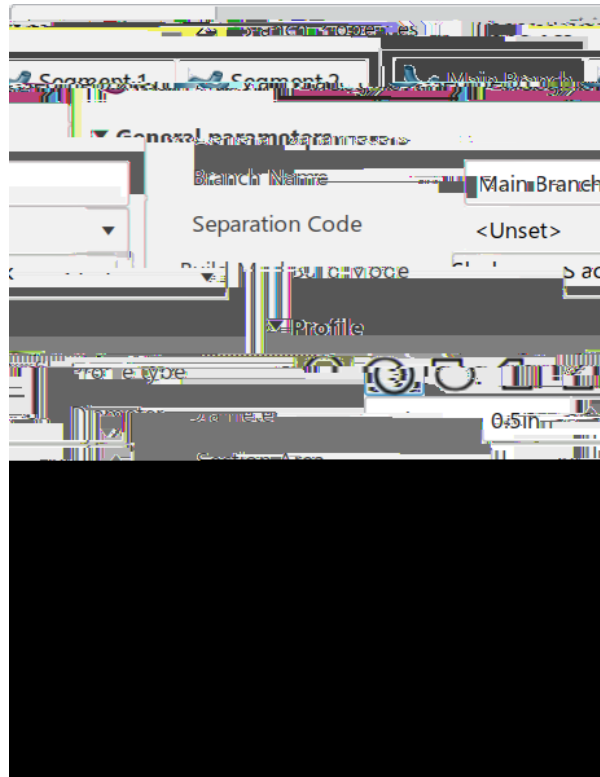

6 ZLWFKSWP ~~Segment~~ KWDE LQ WKH ZLQGR ~~Color~~ DQG FKHQBE WKH
jgnr" {qw"mggr"vtcem"qh"vjg"xctkqwu"ugi o gpvu0"

Cnuq."pqvkeg"vjg"uvctv"cpf"gpf"rqkpvu"kp"vjg"Extremity Management0""Vjgug"xcnwgu"ctg"pqy
ceeguukdng"vq"cf"lwuv"vjg"uvctv"cpf"gpf"nqecvkqpu"qh"vjg"ugi o gpvu0"

6 H O H ~~Segment~~ KWDE DQG ~~Color~~ HW WKH" [qv"Qc{"pggf"vq"ugngev
vjg" 7 D"eg{"vq"igv"vjg"dwpfng"vq"wr fcvg"rtqr gtn{0"

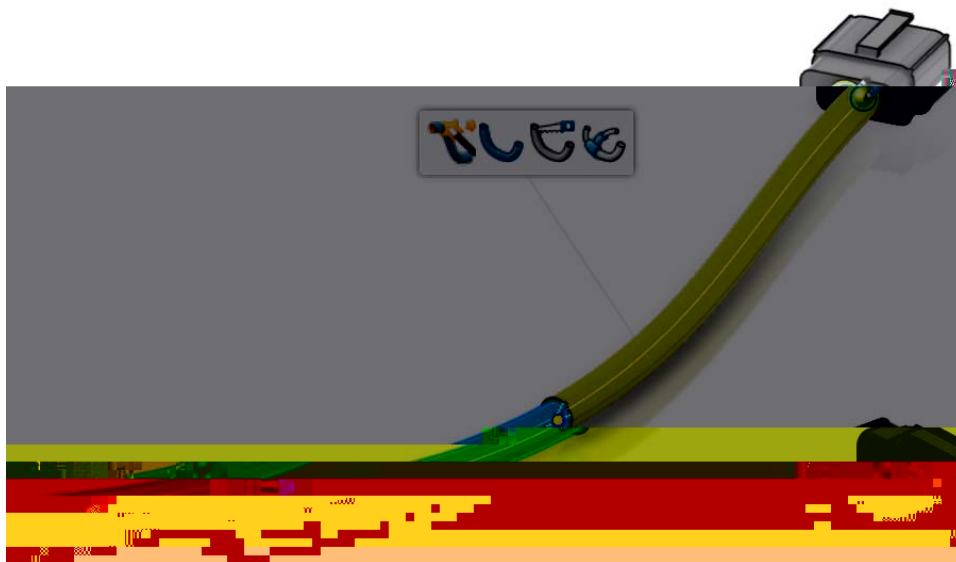

6 HOH Start New Branch LFRQ IURP W I"VWR R Q E D l w "vq"etgcvg
c"pgy"dtepej" ykvj kp"vjg"gzkuvkpi"dtepej"ugv0"

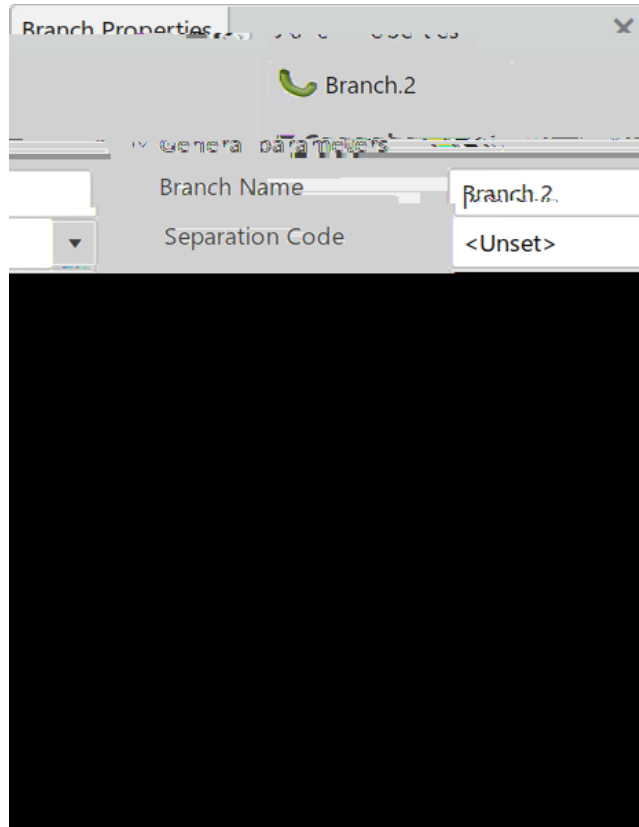

& KDQJ Name WKR 6 LGH %UKDHOFD Name WKR Pqly Qw"ctg"tgcf {
vq"fghkpg"vjg"tqwvg"hqt"vjg"ukfg"dtepej0"

6 HOHFW WKH \HOORZ P x i G q h " c F " h d y U k u " W d y b l q p W j g " D w p f W 0 "

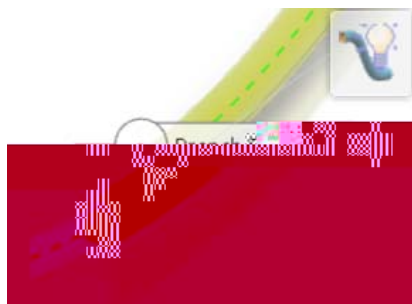

6HOHFW WKH RWKHU jku" ynd"Of"vYg"tkp0jU H SOXJ



Pqvkeg"vjg"vcpigpe{"fqgupøv"nqqm"tki jv0

6HOHFW WKH EUDQFK SRLQW Vg"Kunfc"Ujqwvf"DrvgcVckulqz p0 DERYH



6HOHFW **Tangency Mode** LFRQ LQ WKH WRROEDU D VHOHFW WKH
ujqwnf"crrgct"cu"ujqyp0

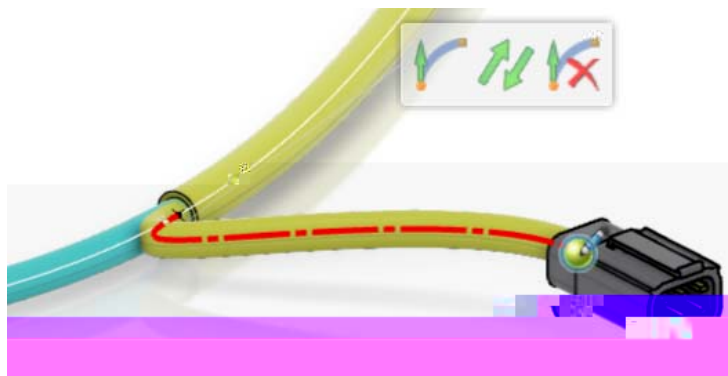

Nqqm"enqugn{"cv"vjg"ur gekhkecvkqp"vtgg0"

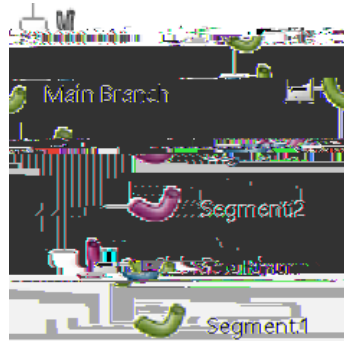

Vjg"pgy"dtcepej"jcu"cp"gzenc o cvkqp"rqkpv"ykvj"c" { gnnqy "qxcn"ctqwpf"kv"vq"kp fkecvg"vjcv"vjg
 dgpf"tcfkwu"oki jv"pqv"jcxg"dggp"tgur gevgf0""Vjku"ku"pqv"c"etkvecn"gttqt."dvw"ku"uq o gv jkpi
 {qw"ykmn"ycpv"vq"ycvej"hqt"y jgp" {qw"kpucnn"vjg"jctpguu"kpqv" {qwt"cuug o dn{0""Kh" {qw"hkp f"vjcv
 {qw"uvknn"jcxg"tcfkwu"kuuwgu"cv"kpucnn"cvkqp."vjgp" {qw" oc { "pggf"vq"nqqm"cv"cf lwuvkpi"vjg"dtcepej
 rqkpv"qt"cffkpi"cffkvkqpcn"uncem0""

6HOH Segment1 KWDE DQG FORVH \RXU GRFXPHQW

6HOHFW LQ WKH GLVSOD\WVW RY knn J & g vjg p g z v W d e j W k k p f 0 E v U D Q F K
 ujqwnf"crrgct"cu"ujqyp0

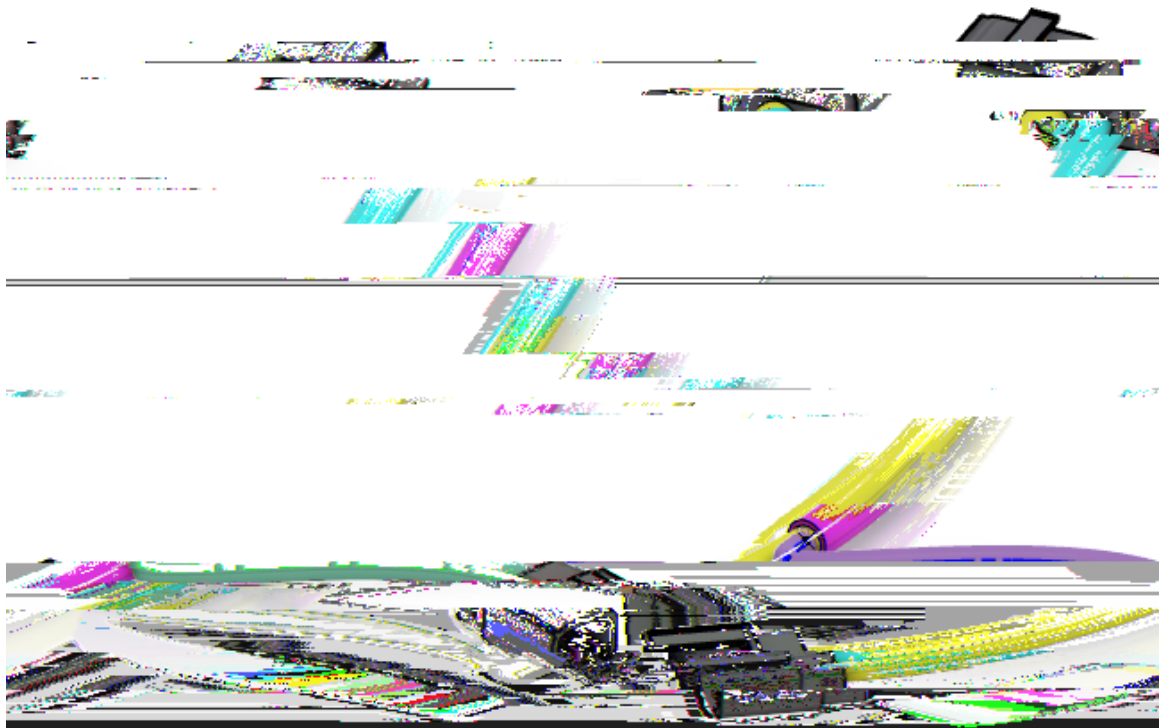

6HOH EXH WKRIQ WR UHW XULQ DVOR W'KW LQJH ZW'UNEHQFK

6DYH DQG FORVH \RXU GRFXPHQW

2 S H Q ELEC090 - Branch Installation SUR GXJFW"uk o rng"dqz"vq"rww"vjg" yktg
jctpguu" {qw"lwuv"etgcygf"kpvcq0"Kv"ujqwnf"cr rget"cu"ujqyp0

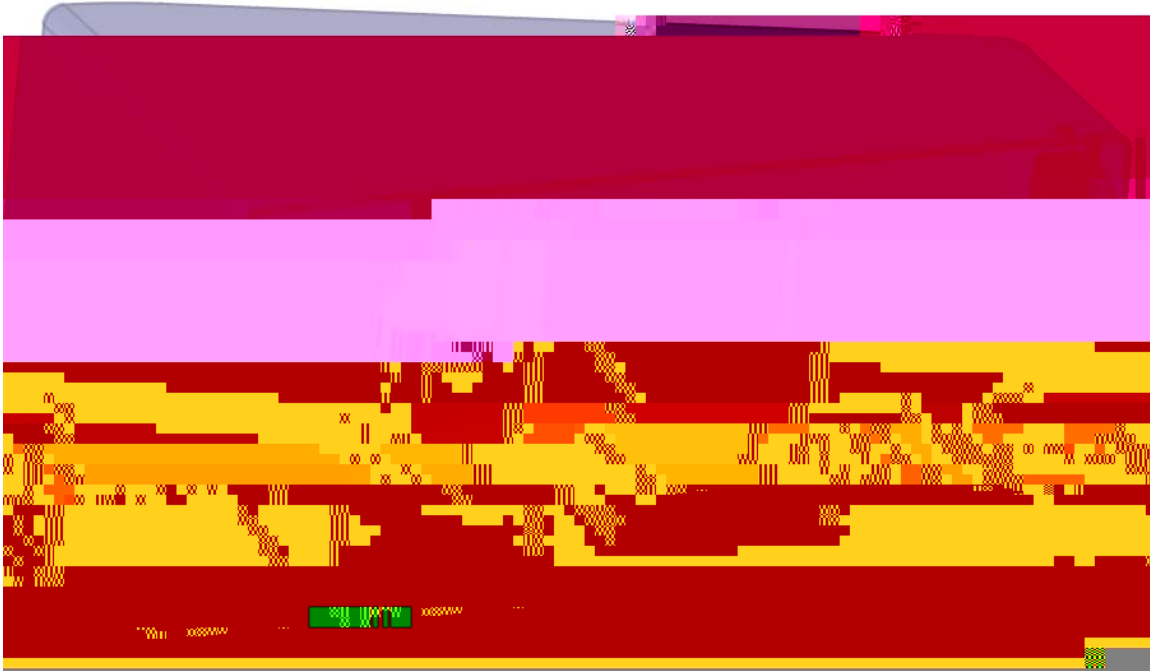

:LWK WKH ULJKW PRXVHEELEC090N Branch Installation VS URFGWIKW
IURP WKH VSHFLILFD Insert Existing Product DQG VHOHFW

6 HDU FK IRU D ELEC090 Multi-Branchable SUR GXJFW"cr rget"cu
ujqyp0

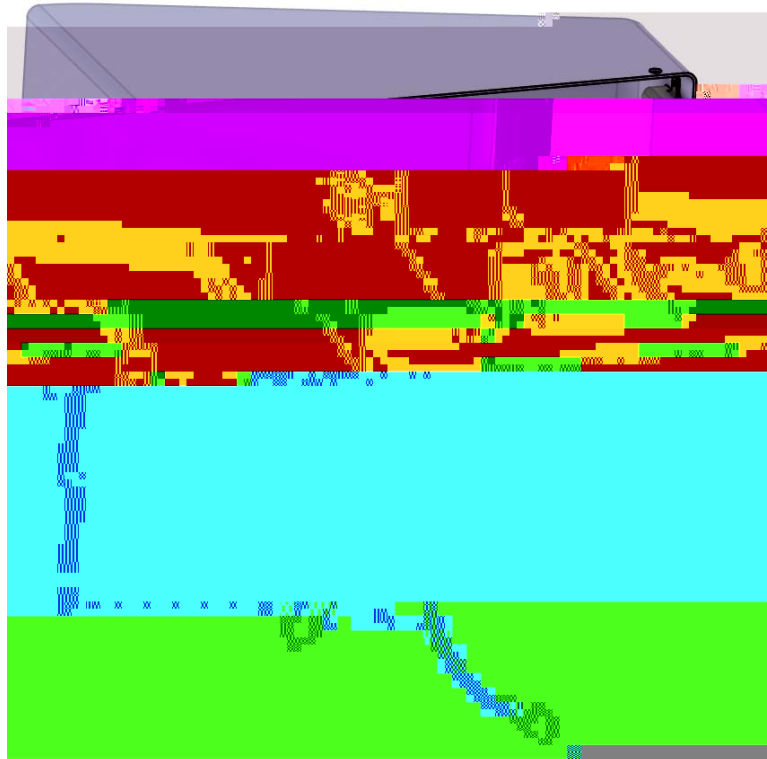

Cv"vjku"rqkpv."{qw"ctg"tgcf{"vq"dgi"kp"o"cmkpi"vjg"pgeguuct{"eqppgevkqpu"vq"kpucnm"vjg"jctpguu
kp"vq"vjg"dqz0"

,I QRW DOUHDG\ VKKH(OHHFWZULWFDKO W'R'FWKpeg(Qw"zg ZR U N E H
eqppgevkpi"vyq"nggevtkecn"eqppgevtu"vq"igvjgt."{qw"ecp"wug"vjg"eqppgev"fgxkegu"vqqnu0"

6 HOHFW WKH **Connect Devices** LFRQ WKHQ VHOHFW WKH FRQQHFWRU
VHJP  Wjku"yknn"kp"fkcev"y"jcv"eqppgevt{"qw"ctg"i"qkpi"vq"eqppgev"hktuv0"

6 HOHFW WKH SLQ FRQQHFWRU"RQ"Vgke"jg"eqppgevtDV VKRZQ
vykeg"kh"kv"ku"kp"xkuwcnk|cvkqp"oqfg0"

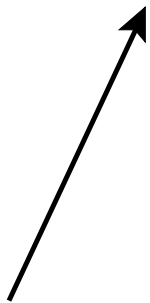

Vcmg"pqvg"qh"vjg"tguwnvki"yktg"dwpfngl"

Pqvkeg"vjg"ugi o gpv"urnk"nqecvkqp0""Ukpeg" {qw" fghkpgf"vjg"urnk" r qkp"vq"dg"8" kpejgu"htq o "vjg

6 HOH Connect Devices LFRQ DJDLQ WKHQ VHOHFW WKH FRQQH
VHJPHQW DQG WKH SLQ  RQVWUHQV RQVWUHQV RQVWUHQV
eqppgevqt0"

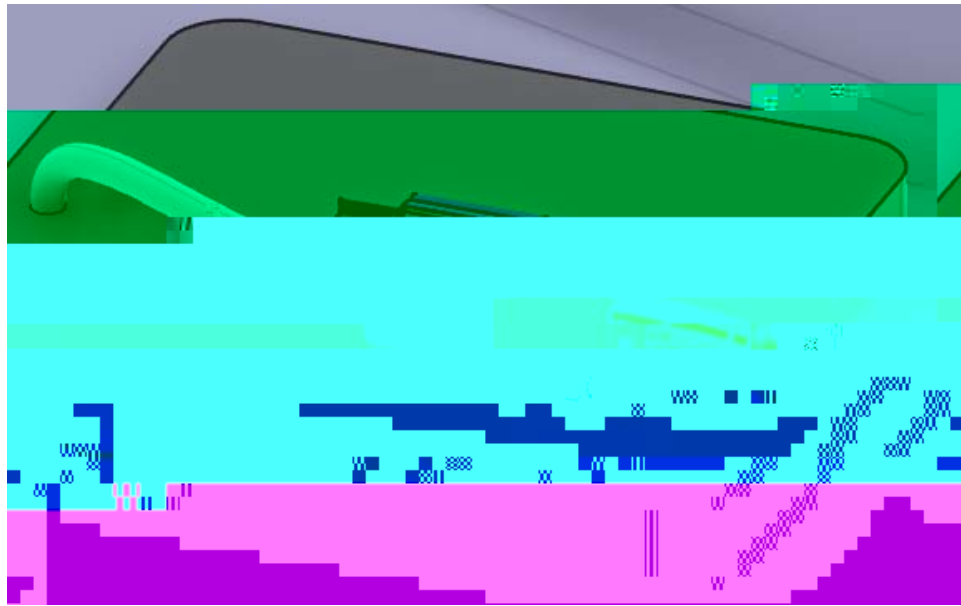

& RQQHFW WKH R  FROQHFW RUV

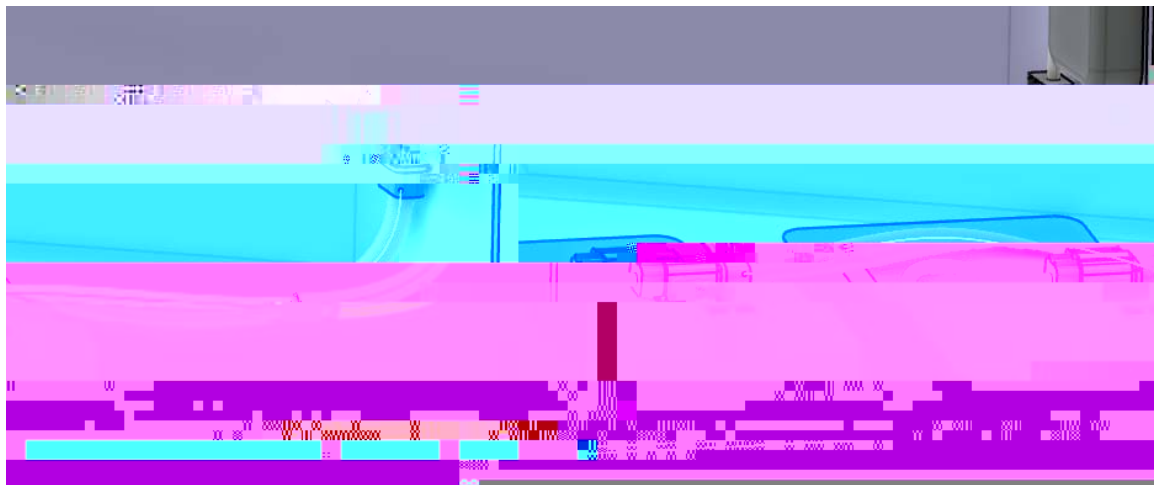

Pqvkeg"vjg"vykuvgf"dtcej0""Vjku"yknn"igv"hkzgf"cu">{qw"dgikp"cfkpi"uwr rqtvu"cpf"qvjgt"nkpmu
vq">{qwt"dtcejgu0"

6DYH DQG FORVH "\RXU GRFXPHQW

Electrical Manufacturing Preparation

Hncvvgpkpi "vjg"dwpfng"ku" i gpgtcnn{ "vjg"hkpcn"uvgr"vq"cp{ "fgxgnqr o gpv"qh" c" i gq o gvtkecn"dwpfng() Dghqtg" c" dwpfng" ecp" dg" o cpwhcevtgfg. "kv" y knn" i gpgtcnn{ "pggf"vq"dg" hncvvgpgf" hqt" fk o gpukqpu qp" yktg"ngpi vj. "cu" y gnn"cu" hqt o "dqctf" fgxgnqr o gpv" cpf" eqppgevqt" ecnn" qwvu0" "Vjgtg" ctg" c" hgy mg{ "rqkpvu"vq"mggr"kp" o kpf" y jgp" hncvvgpkpi { qwt" i gq o gvtke" dwpfng0" Hktuv. "vjg" hncvvgpgf i gq o gvtke" dwpfng" ku" ugrctevg" htq o "vjg" dgpv" i gq o gvtke" dwpfng0" "Vjku" cnnq y u" vjg" hncvvgpgf i gq o gvtke" dwpfng" vq" o ckpvckp" cuuqekcvkxkv{ "kp" fk o gpukqpu" cpf" i gq o gvt{. "dvw" pqv" kp" vjg" ujcrg qh" vjg" dwpfng0" "Vjg" ugeqpf" vjki "vq" mggr" kp" o kpf" ku" vjcv" vjg" hncvvgpgf" fqew o gpv" ku" i gpgtcnn{ wugf" hqt" ftchvki" cpf" HVC" o ctmwr" cpf" cppqvckqpu0" "Cnvj qwi j" vjku" y knn" dg" vqwejgf" qp" jgtg. vjku" y knn" pqv" dg" vjg" hqewu" qh" vjku" ugevqpp0"

Formboard Creation

Vjg" hqt o dqctf" cpf" rtgrctg" nc{ qwv" qrvkqpu" ctg" vjg" pgy guv" o gvjqfu" hqt" etgcvki" jctpguu hncvvgpkpi0" "Vjku" ugevqpp" y knn" fg o qpvtcvg" vjg" rtqegu0"

2 S H Q **EMEC340 - Flattening Orientation** G R F X P **HuQWf** crrgct"cu"ujqyp0

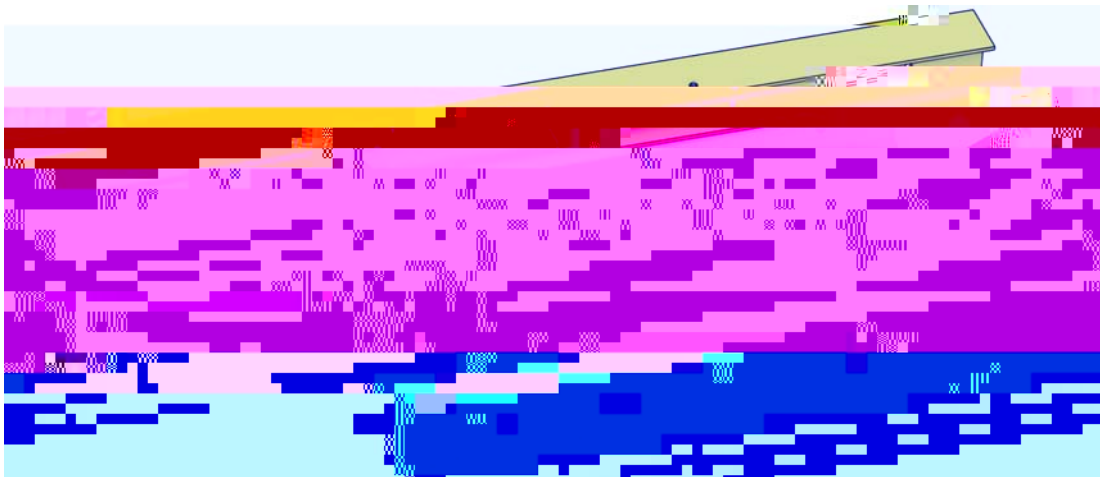

6 H O H **Formboard** L F  "Vjg" Formboard Process ykpfqy" crrgctu0

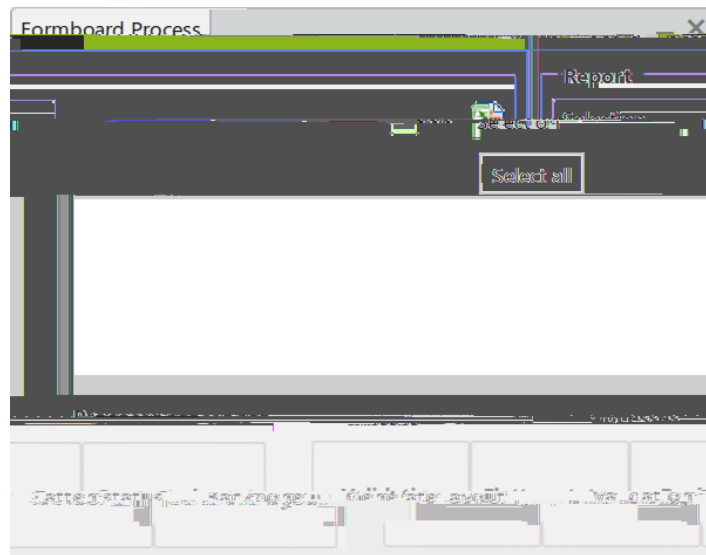

6 H O H ~~Electrical~~ **Electrical Geometry** L Q W K H W U H H W R G H I L Q M Z K D W Z L O
ujqwnf"errget"kp"vjg"ykpfaqy"cpf"kv"ujqwnf"jki jnki jv"kp"vjg"fkurnc{0

6 H O H ~~Validation~~ **HE X W WgRj Q** pguu"ujqwnf"jki jnki jv"itggp"cu"ujqyp0

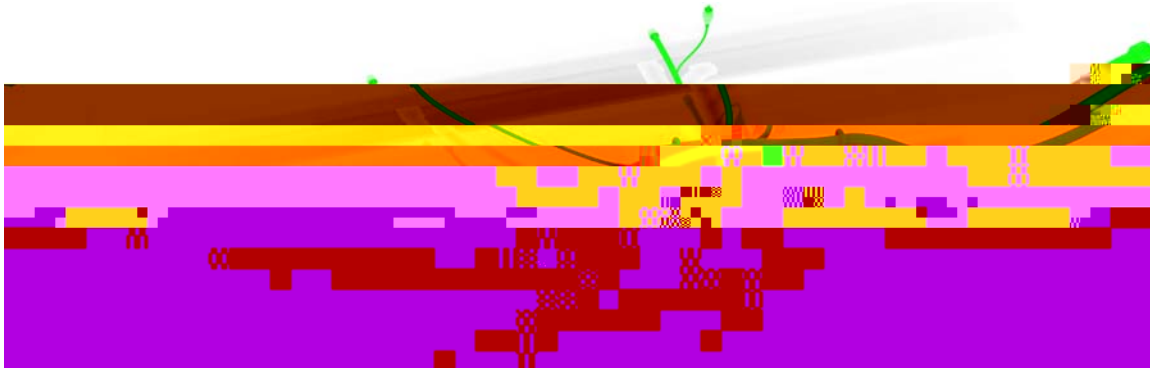

I tggp Urgekhkgu"vjg"dtcpej"ecp"dg"hncvpgpf

[gmqy Urgekhkgu"vjg"dtcpej"ecppqv"dg"hncvpgpf

Oci gpcv Urgekhkgu"vjg"dtcpej"ecp"dg"hncvpgpf."dvw"y km"pqv"dg"vutcki jvpgpf

Dnwg Urgekhkgu"vjg"dtcpej"ku"cntgcf{"hncvpgpf

6 H O H ~~Attention~~ **HE X W W R Q L Q W K H Z L j Q G R Z** cp"itggp0

6 H O H ~~Backbone~~ **HE X W WgRj Q** p"dtcpej"ujqwnf"ejcpig"vq"rkpm"cpf"ujqwnf"jcxg"vjg
uvctv"cpf"gpf"ncdngf0

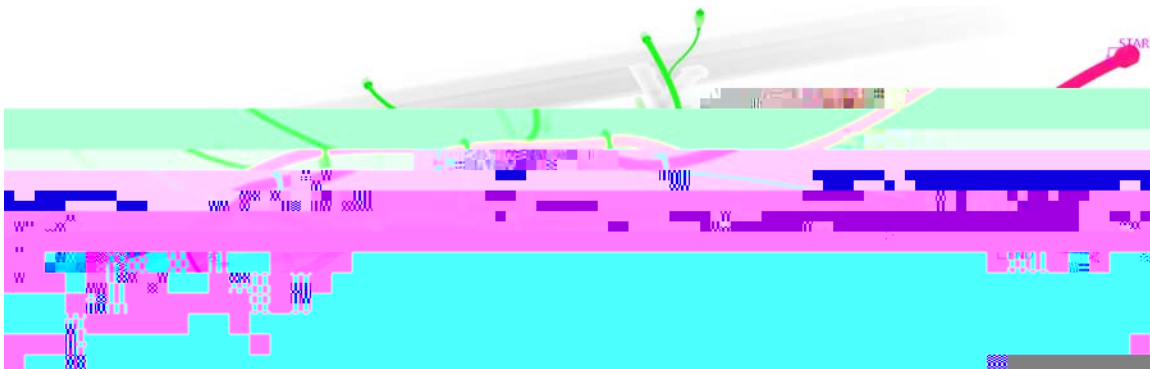

6 H O H G u n e r W e k a y b u t E X W W p y Q r t q f w e v " k u " e t g c v g f " k p " c " p g y " v c d 0 " " V j g
Formboard Process" y k p f q y " u j q w n f " c r r g c t " c u " u j q y p 0



& O R V F o r m b o a r d P r o c e s s Z L Q G R Z D Q G V Z L W F K W R K v W y d w n f Q H Z S U R G
c r r g c t " c u " u j q y p 0

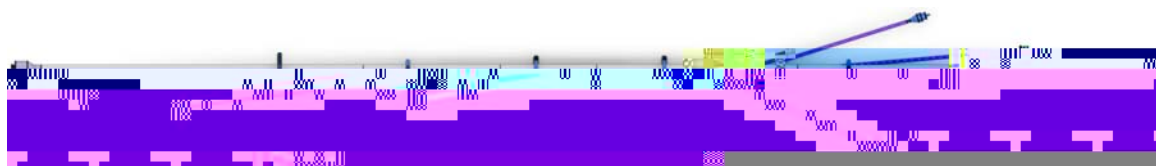

V j g " g p v k t g " j c t p g u u " y c u " d t q w i j v " q x g t " k p e n w f k p i " c p { " k p v g t p c n " g n g e v t k e c n " e q p p g e v q t u 0 " " P q v k e g " c
u g r c t e v g " r t q f w e v " y c u " e n u q " e t g c v g f " v j c v " k p e n w f g u " c p { " u w r r q t v u " v j c v " y g t g " w u g f " d { . " d w v " p q y
k p v g t p c n " v q " v j g " j c t p g u u 0 " " "

Prepare Layout

CATIA Electrical Harness Design

6HOHFW QH DU WKH HQG RI WKH VPD OO EUDQFK

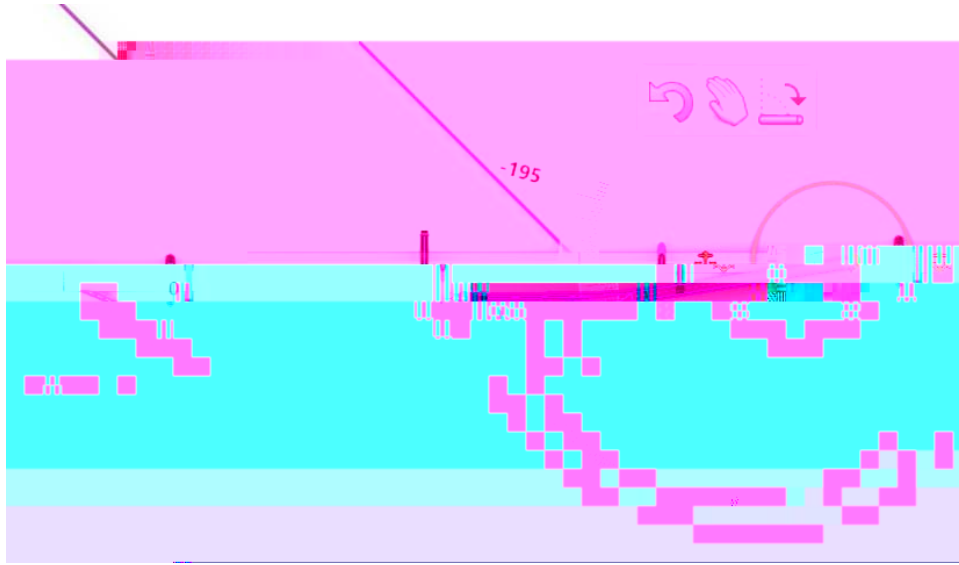

5RWDWH WKH EUDQFK WR

GHJUHHV DQG VHOHFW LQ VSI

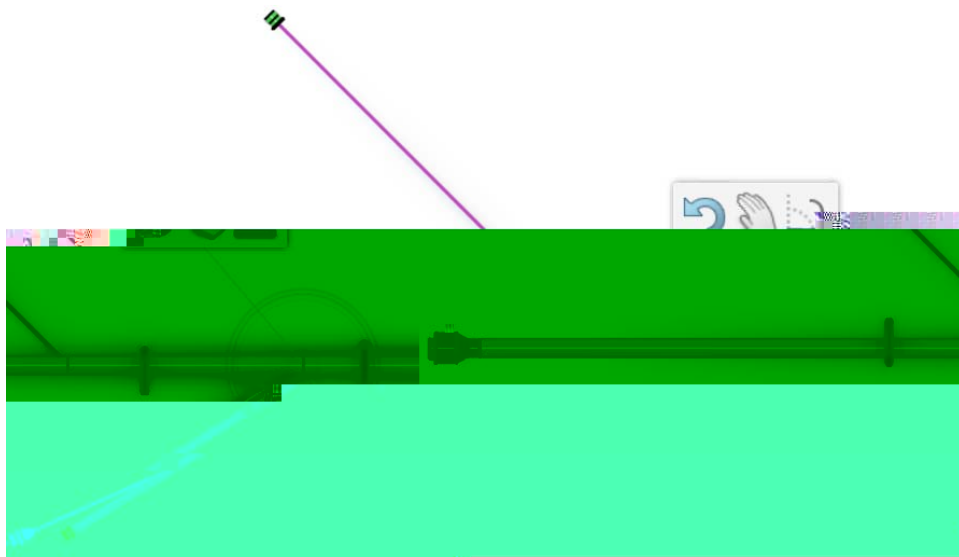

6HOHFW WKH HQG RI WKH VPD OO EUDQFK D QSG RVR W DGLHQ J WU W
GHJUHHV 6HOHFW "VQ" yknsD "F" HtczngkVj "Qg" GkP Qdpej0

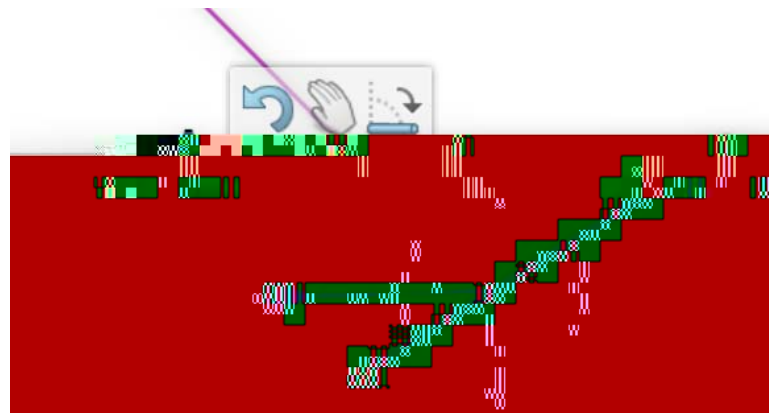

6 HOH **Prepare Layout** LFRQ WR FRPSOHWF "Kjg" j Rpgu Q DDQLSXODWLRQ
ujqwnf"crrgct"cu"ujqyp0

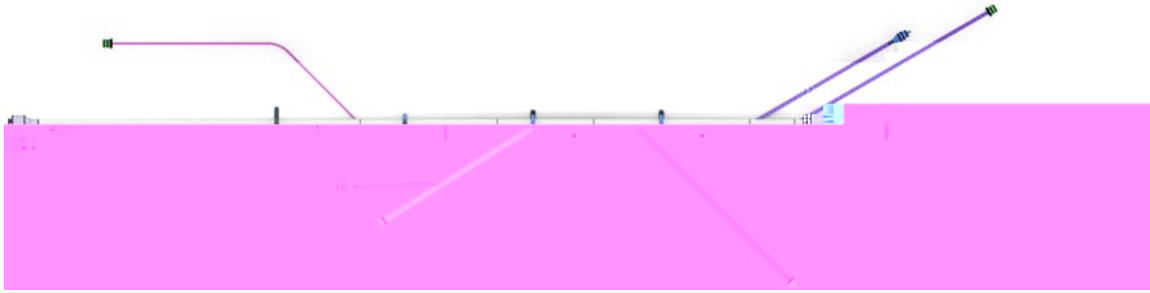

5HQDPH WKH WRS OHYHO SURGXFW DQG WKH VXE DVVHPEO



6DYH WKH **EXPLODE** "Bng" QW jg"pgzv"gzgtekug0