



Airbus/WSU High School Wingbox Challenge

*Showcase your aviation heritage
Design and build the lightest, strongest, and stiffest Wingbox possible!*

Prize money

1st Prize : \$1000

2nd Prize : \$500

3rd prize : \$250

Deadline : March 29th, 2025

The Challenge

Wings are a critical part of airplanes

They carry the weight of the plane

They are necessarily long and skinny

The wingbox is the core structure of the wing

Engineers work very hard to make the wingbox light, strong, and stiff

Here is a chance for you to do the same, & more!

Work with Airbus & WSU engineers

Start your future with WSU & with Airbus

Win prize money!

The Challenge..

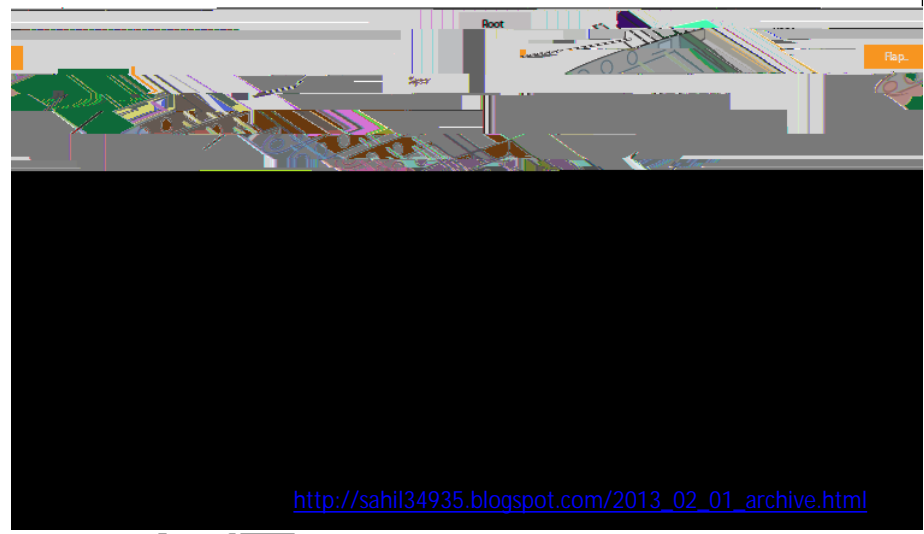

<https://theallnewairbusa350wb.wordpress.com/2013/02/08/the-all-new-airbus-a350wb/>

http://sahil34935.blogspot.com/2013_02_01_archive.html

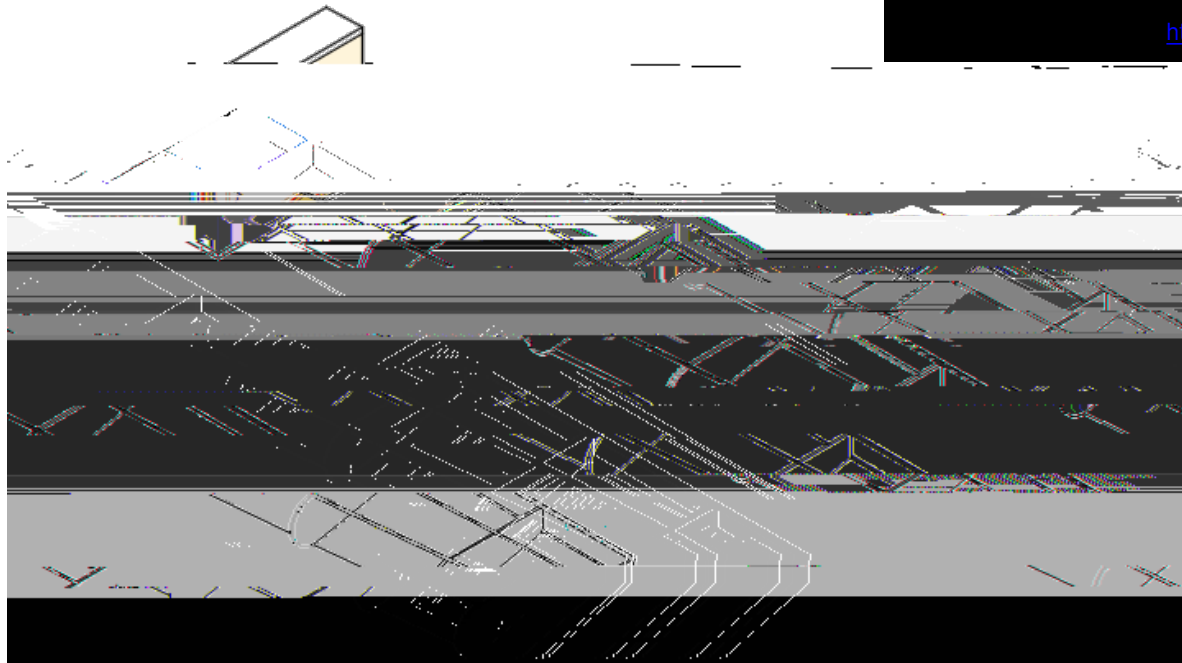

The Challenge

Using balsa sticks, design and build the lightest^A, strongest^B, and stiffest^C

Deliverables

- Deadline : 5 p.m., March 29th, 2025
- A summary report (not exceeding 5 pages in Word format, 12pt font, single spacing, 1" margins) outlining the following:
 - Team name, affiliation, list of Team members, & mentors
 - Summary of your design (why you decided to build the wingbox a certain way) and a simple drawing identifying the various parts
 - Summary of activities (materials used, time spent in design, constructing, testing, etc.). Photographs of activities are also welcome.
 - Estimate how much load (P) your wingbox will withstand and how much the tip will deflect (e)-1 (c)-2 (i)-t5 (a)-(t)1022.6an

Testing of Wingboxes

- The Wingboxes will be tested during the Annual Engineering Open House (~ 1st week of May. Exact dates will be announced when they become available).
- The Wingboxes will be prepared for testing (ends casted, loaders mounted) after the teams submit their wingboxes to WSU

Wingbox overall Geometry

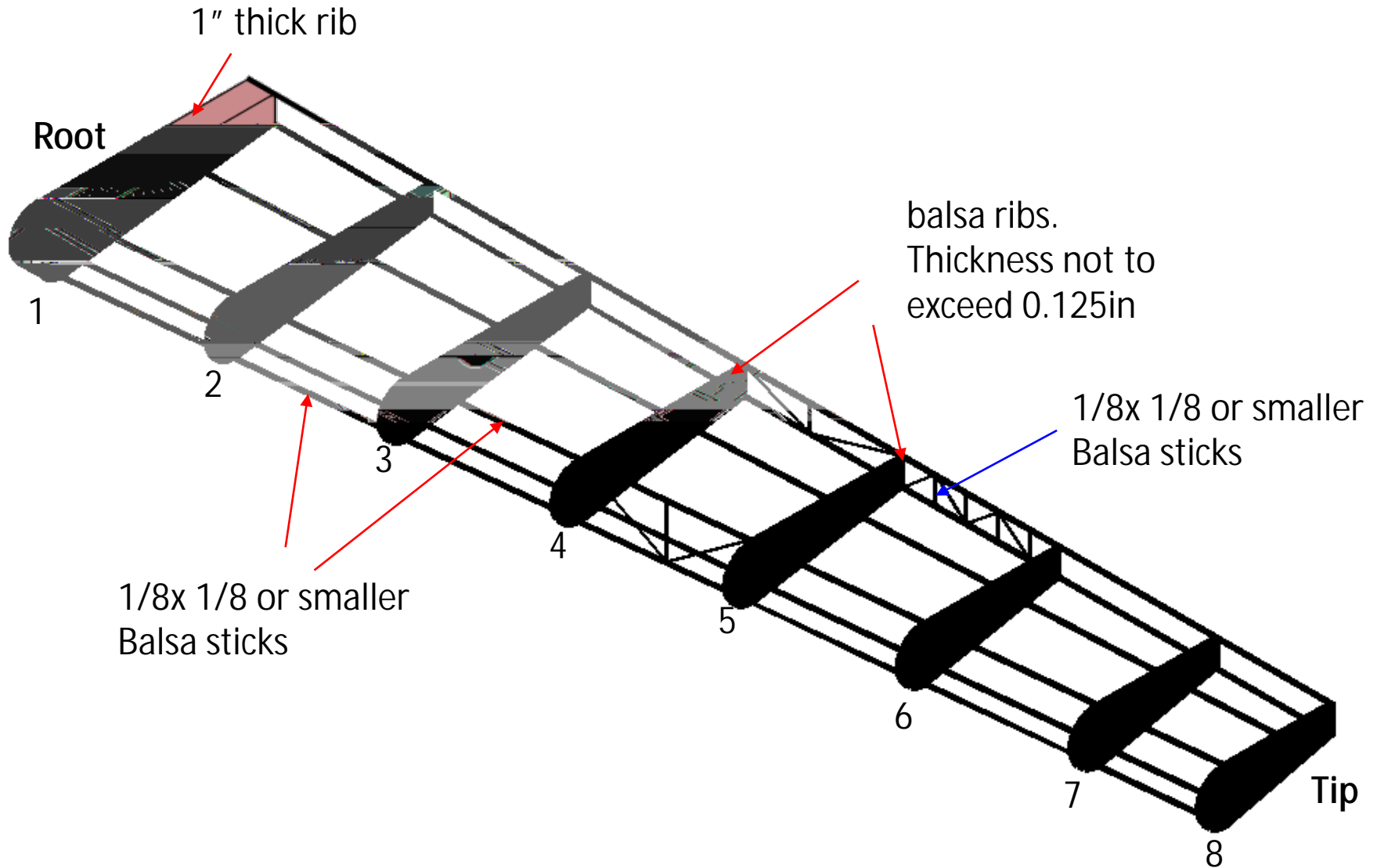

Note : The arrangement of balsa sticks are for illustration only. Your design may require balsa sticks to be placed elsewhere.

Wingbox overall Geometry..

Top View

Tip View

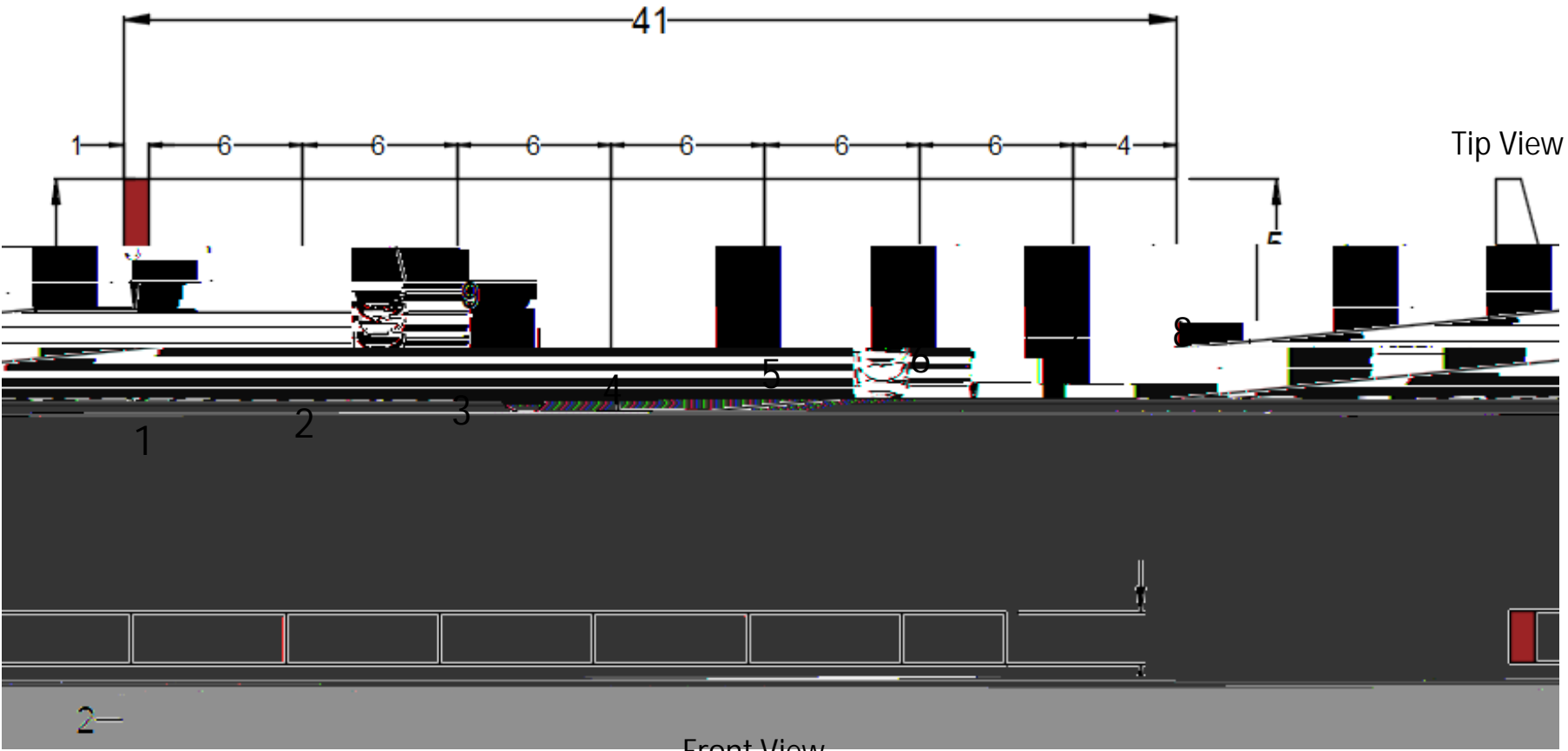

Front View

Dimensions in inches

NOTE (1): Acceptable configuration examples....

Must
extend till
this edge

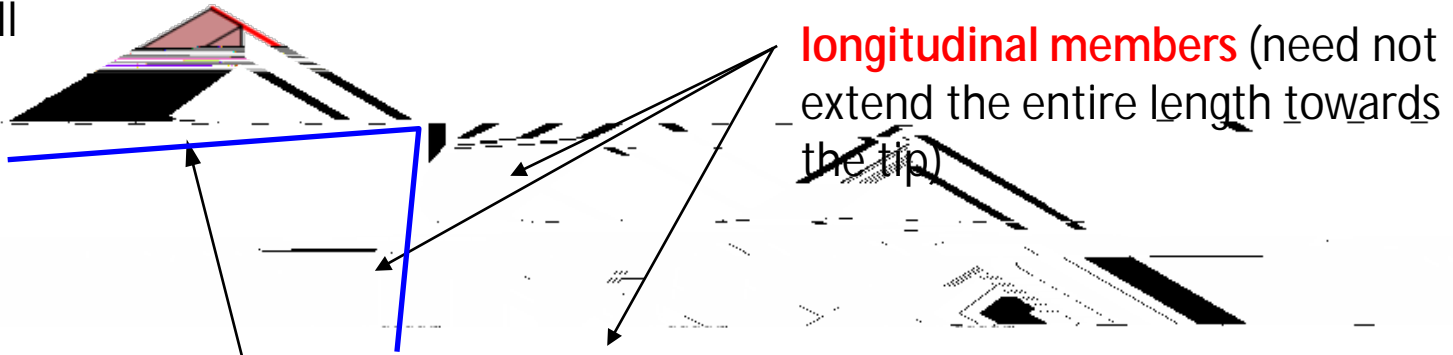

longitudinal members (need not
extend the entire length towards
the tip)

Diagonal members

Use any combination of longitudinal and diagonal members.

Rib Geometry..

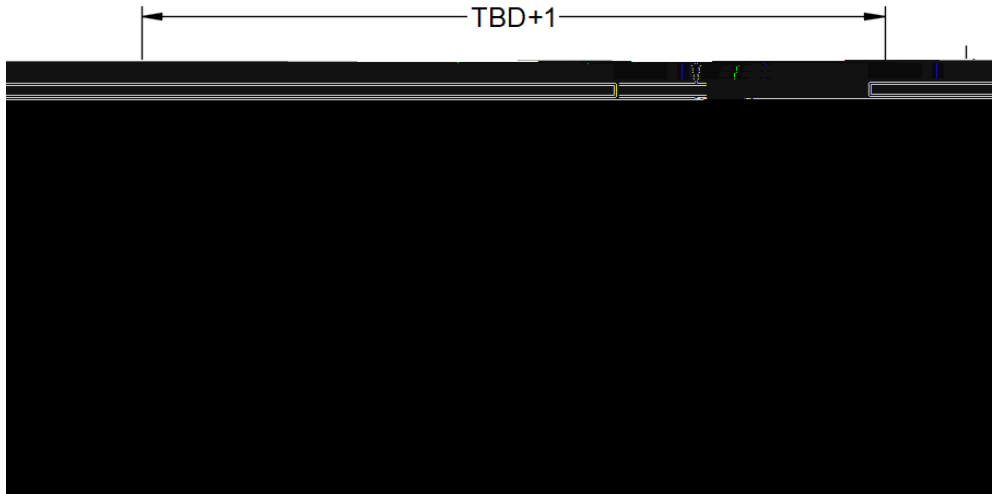

Ribs # 2 thro 7

- Lightening holes allowed.
- You may cut recesses for balsa sticks along the perimeter.
- The dimension 'TBD' should be based on overall geometry of the wingbox

Note : Ribs 1 to 8 (and their locations) are mandatory. You may add additional ribs in between them as required. While additional ribs may help the load carrying capability of your wing, they will also add weight.

Dimensions in INCHES

Recesses for balsa sticks

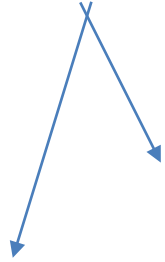

Lightening holes



Rib stiffeners

NOTE (2):

- The balsa sticks (extending the length of the wingbox) must pass through recesses cut in the ribs. For illustration purposes, rib #2 has been shown. The overall dimensions of the other ribs may be determined using the geometry of the wingbox
- Once you have decided on the locations and dimensions of the recesses in the ribs, you may utilize the **laser cutter** at WSU to have your ribs cut precisely.
- You may bond stiffeners (balsa sticks)to strengthen the ribs as necessary.

Design Constraints

- Materials
 - Balsa sheets may not be used as beams (spars) along the length
 - Balsa sticks with only 1/8-inch square or smaller (square) cross-section dimensions are allowed
 - Any combination of above balsa sticks may be used
 - No more than 3 balsa sticks may be placed adjacent to each other or clustered together. A gap of $w(n+1)$ must be maintained between adjacent clusters. Here, w is the width of the stick (0.125in) and n is the number of sticks in the larger of the two adjacent clusters.

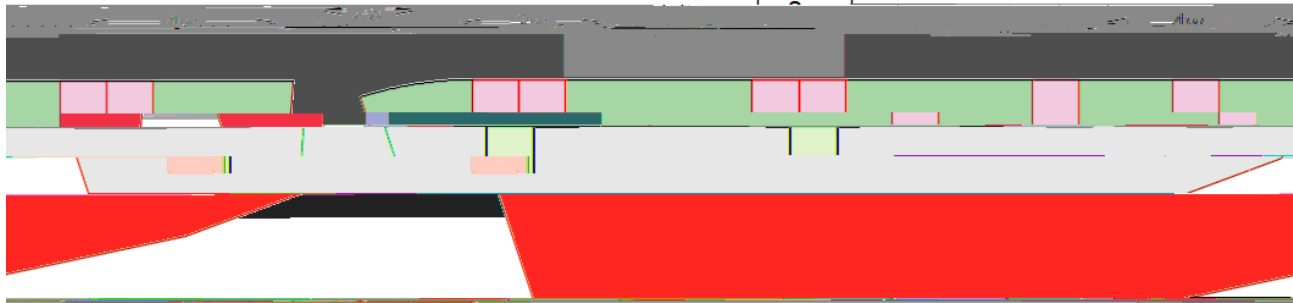

Design Constraints..

- Materials...
 - The balsa sticks running along the length must be 41-inches long. They must extend over the first rib (on the root end) as illustrated in the figure.
 - The mandatory balsa ribs (Nos. 1 to 8) must be placed at locations called out in the figure. These ribs must be no greater than 1/8-inch thick.
 - Recesses may be cut along the edges of the ribs if necessary
 - You may cut lightening holes (to reduce weight) in the ribs (2 thro 7)
 - You may place additional ribs in between as required by your design. Note that adding material increases weight.
 - Use hobby store adhesives for bonding (Superglue, epoxy, etc.)

Wingbox Challenge Rubric

- Wingbox designs are scored based using the following:

$$\text{Score } S = S_1 + S_2 + S_3 - S_4 + S_5$$

- S_1 (Maximum of 20 points). A deduction of 1 point for exceeding 0.1" in the overall dimensions
- $S_2 = (P_f/W) \times 10$
 - P_f

Airbus/WSU High School Wingbox Challenge 2024-25

ENTRY FORM

School Name & District: _____